



EN
FR
ES

CD/HD Radio™/ADVANCED BLUETOOTH WITH SiriusXM Tuner CDE-HD149BT



- OWNER'S MANUAL
Please read before using this equipment.
- MODE D'EMPLOI
Veuillez lire avant d'utiliser cet appareil.
- MANUAL DE OPERACIÓN
Léalo antes de utilizar este equipo.

Thank you for purchasing this Alpine product. Please take a moment to protect your purchase by registering your product now at the following address: www.alpine-usa.com/registration. You will be informed of product and software updates (if applicable), special promotions, news about Alpine, and entered for a chance to win prizes.

Merci d'avoir acheté ce produit Alpine. Nous vous invitons à consacrer un moment à la protection de votre achat en enregistrant votre produit dès maintenant à l'adresse suivante : www.alpine-usa.com/registration. Vous serez tenu informé des mises à jour des produits et des logiciels (le cas échéant), des promotions spéciales, de l'actualité d'Alpine, et vous aurez une chance de remporter des prix.

Gracias por adquirir este producto Alpine. Con solo unos pocos pasos podrá proteger su producto, registrándolo a través de la siguiente dirección: www.alpine-usa.com/registration. Recibirá información sobre nuevos productos y software, promociones especiales, novedades sobre Alpine y participará en el sorteo de premios.

ALPINE ELECTRONICS OF AMERICA, INC.
19145 Gramercy Place, Torrance,
California 90501, U.S.A.
Phone 1-800-ALPINE-1 (1-800-257-4631)

ALPINE ELECTRONICS OF CANADA, INC.
777 Supertest Road, Toronto,
Ontario M3J 2M9, Canada
Phone 1-800-ALPINE-1 (1-800-257-4631)

ALPINE ELECTRONICS MARKETING, INC.

1-7, Yukigaya-Otsukamachi, Ota-ku,
Tokyo 145-0067, JAPAN
Phone: 03-5499-4531

ALPINE ELECTRONICS FRANCE S.A.R.L.

(RCS PONTOISE B 338 101 280)
98, Rue de la Belle Etoile, Z.I. Paris Nord II,
B.P. 50016, 95945 Roissy Charles de Gaulle
Cedex, France
Phone 01-48638989

ALPINE ELECTRONICS OF AUSTRALIA PTY. LTD.

161-165 Princes Highway, Hallam
Victoria 3803, Australia
Phone 03-8787-1200

ALPINE ELECTRONICS GmbH

Wilhelm-Wagenfeld-Str. 1-3, 80807 München, Germany
Phone 089-32 42 640

ALPINE ELECTRONICS OF U.K. LTD.

Alpine House
Fletchamstead Highway, Coventry CV4 9TW, U.K.
Phone 0870-33 33 763

ALPINE ITALIA S.p.A.

Viale C. Colombo 8, 20090 Trezzano
Sul Naviglio (MI), Italy
Phone 02-484781

ALPINE ELECTRONICS DE ESPAÑA, S.A.

Portal de Gamarra 36, Pabellón, 32
01013 Vitoria (Alava)-APDO 133, Spain
Phone 945-283588

Operating Instructions

WARNING

WARNING	6
CAUTION	6
PRECAUTIONS	6

Getting Started

Accessory List	9
Turning Power On and Off	9
Source Selection	9
Detaching and Attaching the Front Panel	9
Detaching	9
Attaching	9
Initial System Start-Up	10
Adjusting Volume	10
Lowering Volume Quickly	10
Setting the Time and Calendar	10

HD Radio™ Reception

Listening to Radio	11
Presetting Stations Manually	11
Presetting Stations Automatically	11
Tuning to Preset Stations	11
Frequency Search Function	12
Receiving a Multicast Station	12
Multicast Station Search	12
Storing the tag information	12
About the Feature Logos	13

CD/MP3/WMA/AAC

Playback	13
Repeat Play	14
M.I.X. (Random Play)	14
Searching for CD Text	14
Folder/File Name Search (Concerning MP3/WMA/AAC)	14
Folder Name Search mode	14
File Name Search mode	14
Search Position Memory	14
About MP3/WMA/AAC	15
Terminology	16

Sound Setting

Adjusting Subwoofer Level/Bass Level/ Treble Level/Balance (Between Left and Right)/ Fader (Between Front and Rear)/Defeat	16
Audio Setup	17
Equalizer Presets (Factory's EQ)	17
Adjusting the Parametric Equalizer Curve (Parametric EQ)	17
Adjusting the Band	17
Adjusting the Frequency (Freq.)	17
Setting the Bandwidth (Q)	17
Adjusting the Level	17
Setting the Source Volume Level	17
Turning Subwoofer ON/OFF	18
Setting the Subwoofer Phase	18
Setting the Subwoofer System	18
External Device	18
Connecting to an External Amplifier	18
Setting the Media Xpander mode (MX Setup)	18
Customizing the Media Xpander setting	18
Setting the Time Correction Unit (TCR Parameter)	19
Adjusting the Time Correction (T.Correction)	19
Adjusting SPATIAL	19
Adjusting the Crossover Settings (X-Over)	19
Adjusting the Channel (Ch.)	19
Selecting the Cut-Off Frequency (Freq.)	19
Adjusting the Slope	19
Adjusting the Level (Lev.)	19
Storing the Parametric EQ/T.Correction/ X-Over Settings	19
Recalling the Stored Parametric EQ/ T.Correction/X-Over Settings	20
About Time Correction	20
Example 1: Front Left Seat	20
Example 2: All Seats	20
About the Crossover	21

Other Functions

Displaying the Text	22
About the indication display	23
About "Text"	23
Option Menu Setting	23
Applying Tunelt	24
Adjusting the sound via Smartphone	24
Facebook Notification Function	25
Receiving Notification (Ready on future update)	25
Displaying Notification List (Ready on future update)	25

SETUP

Setting	25
General Setting	26
Setting the Clock Display (Clock Mode)	26
Setting of Calendar Display Pattern Switching (Calendar)	26
Setting the AUX SETUP mode	26
Setting the AUX NAME mode	26
Playing MP3/WMA/AAC Data (Play Mode)	26
Sound (Beep) Guide Function	26
Demonstration	26
Display Setting	26
Changing Lighting Color	26
Dimmer Control	27
Dimmer Level Setting	27
Scroll Type Setting	27
Scroll Setting (Text Scroll)	27
Opening Message ON/OFF Setting	27
Tuner Setting	27
Setting the Multicast Seek	27
Setting the Digital Seek	27
Switching the listening mode	27
Setting the Live mode (Live Mode)	27
Setting the TUNER (FM) tone quality	28
iPod&USB Setting	28
Setting the USB Skip function	28
iPod/iPhone Search Mode Setting	28
Application Setting (APP)	28
Setting the communication mode with a Smartphone (Alpine APP)	28
Setting the TTS (Text To Speech) volume	28

BT Hands Free Calling

Setup Before Using	29
About BLUETOOTH	29
Before Using BLUETOOTH Function	29
How to connect to a BLUETOOTH compatible device (Pairing)	29
Pairing a BLUETOOTH compatible device with SSP (Secure Simple Pairing)	29
Pairing a BLUETOOTH compatible device without SSP (Secure Simple Pairing)	29

BLUETOOTH SETUP	30
Setting the BLUETOOTH Connection (Bluetooth IN)	30
Setting the BLUETOOTH Device	30
Setting the Visible Mode	30
Pairing a BLUETOOTH Device from the unit	30
Setting the BLUETOOTH sound quality	31
Adjusting the volume (VOL LV ADJ)	31
Sound Type setting (Type Setup)	31
Setting the caller information display/text message indicator ON/OFF	31
Setting the Phone Book Update	31
Setting the Phone Book Auto Update ON/OFF (Auto)	31
Setting the Phone Book Manual Update ON/OFF (Manual)	31
Changing the Phone book List Order	31
Setting the Received Calls automatically (Auto Answer)	32
Displaying the phone service provider name	32
Selecting the output speaker	32
Displaying the firmware version	32
Updating the firmware	32
Hands-Free Phone Control	32
About the Hands-Free Phone	32
Answering a Call	32
Hanging up the Telephone	32
Voice Control Operation	32
Calling	33
Redialing a Number In Outgoing History	33
Dialing a Number In Incoming History	33
Dialing a Number In Incoming Missed Call History	33
Dialing a Number In The Phone Book	33
Phone book Alphabet Search Function	33
Call waiting function	34
Preset a number in the Phone Menu (Shortcut dial)	34
Dialing the preset number	34
Adjusting the volume when receiving a Call	34
Muting the microphone input quickly (Voice Mute)	34
Call Switching Operation	34
Bluetooth Audio Operation	34
Recalling the Bluetooth Audio Mode	35
Selecting the desired Song	35
Pausing	35
Selecting the desired Group (Folder)	35
Searching for a desired song	35

Flash Memory (optional)

Connecting the Flash Memory (optional).....	35
Playback	35
Repeat Play.....	36
M.I.X. (Random Play)	36
Searching for a desired Song.....	36
Select Folder	36
Search Position Memory	36

iPod/iPhone (optional)

Connecting an iPod/iPhone	37
Setting the iPod Control.....	37
Playback	37
Searching for a desired Song.....	38
Direct Search Function.....	38
Change Playlist/Artist/Album/Genre/ Composer/Episode.....	39
Alphabet search function	39
Search Position Memory	39
Random Play Shuffle (M.I.X.)	39
Repeat Play.....	39
Displaying the Text.....	40

Pandora® internet radio (Optional)

Listening to Pandora®	40
“Thumbs” Feedback.....	41
Searching for a Desired Station	41
QuickMix	41
Bookmarking a Desired Song or Artist.....	41
Creating a New Station	41
Search Position Memory	42
Changing the Display	42
About the indication display	42

SiriusXM Satellite Radio Operation (Optional)

Receiving Channels with the SiriusXM Tuner.....	42
SiriusXM Setting	43
Managing Artist and Song Alerts.....	43
Setting the Favorite Sports Team Alerts	43
Setting the Parental Control	43
Confirming the strength of the SiriusXM signal	44
Checking the SiriusXM Radio ID Number.....	44
Storing Channel Presets	44
Tuning Channels using Presets	44

Storing the desired Artist and Song Alerts.....	44
Receiving and Tuning to an Alert	45
Search Function	45
Searching by Channel.....	45
Searching by My Music.....	45
Searching by My Games.....	45
Using Jump Memory and Jump Recall function.....	45
Replay Function.....	46
Parental Lock Function	46
Storing iTunes Tagging information	46
Changing the Display.....	46
About the indication display	46

Information

In Case of Difficulty	47
Basic.....	47
Radio	47
CD.....	47
MP3/WMA/AAC.....	47
Audio.....	47
iPod.....	47
Indication for CD Player.....	47
Indication for Flash Memory	48
Indication for iPod Mode	48
BLUETOOTH mode	48
SiriusXM Advisory Messages	48
Indication for Pandora® Mode.....	49
Specifications	50

Installation and Connections

Warning	51
Caution	51
Precautions	51
Installation	52
Removal	52
iPod/iPhone Connection (sold separately).....	53
Remove the iPod/iPhone.....	53
Flash Memory Connection (sold separately).....	53
Connect Flash Memory	53
Remove Flash Memory.....	53
Mounting the Microphone.....	53
Using the Rear AUX Input Connector.....	53
Connections	54

LIMITED WARRANTY

Operating Instructions

WARNING

WARNING

This symbol means important instructions. Failure to heed them can result in serious injury or death.

DO NOT OPERATE ANY FUNCTION THAT TAKES YOUR ATTENTION AWAY FROM SAFELY DRIVING YOUR VEHICLE.

Any function that requires your prolonged attention should only be performed after coming to a complete stop. Always stop the vehicle in a safe location before performing these functions. Failure to do so may result in an accident.

KEEP THE VOLUME AT A LEVEL WHERE YOU CAN STILL HEAR OUTSIDE NOISES WHILE DRIVING.

Excessive volume levels that obscure sounds such as emergency vehicle sirens or road warning signals (train crossings, etc.) can be dangerous and may result in an accident. LISTENING AT LOUD VOLUME LEVELS IN A CAR MAY ALSO CAUSE HEARING DAMAGE.

DO NOT DISASSEMBLE OR ALTER.

Doing so may result in an accident, fire or electric shock.

USE ONLY IN CARS WITH A 12 VOLT NEGATIVE GROUND.

(Check with your dealer if you are not sure.) Failure to do so may result in fire, etc.

KEEP SMALL OBJECTS SUCH AS BATTERIES OUT OF THE REACH OF CHILDREN.

Swallowing them may result in serious injury. If swallowed, consult a physician immediately.

USE THE CORRECT AMPERE RATING WHEN REPLACING FUSES.

Failure to do so may result in fire or electric shock.

DO NOT BLOCK VENTS OR RADIATOR PANELS.

Doing so may cause heat to build up inside and may result in fire.

USE THIS PRODUCT FOR MOBILE 12V APPLICATIONS.

Use for other than its designed application may result in fire, electric shock or other injury.

DO NOT PLACE HANDS, FINGERS OR FOREIGN OBJECTS IN INSERTION SLOTS OR GAPS.

Doing so may result in personal injury or damage to the product.

CAUTION

This symbol means important instructions. Failure to heed them can result in injury or material property damage.

HALT USE IMMEDIATELY IF A PROBLEM APPEARS.

Failure to do so may cause personal injury or damage to the product. Return it to your authorized Alpine dealer or the nearest Alpine Service Center for repairing.

PRECAUTIONS

Product Cleaning

Use a soft dry cloth for periodic cleaning of the product. For more severe stains, please dampen the cloth with water only. Anything else has the chance of dissolving the paint or damaging the plastic.

Temperature

Be sure the temperature inside the vehicle is between +60°C (+140°F) and -10°C (+14°F) before turning your unit on.

Moisture Condensation

You may notice the CD playback sound wavering due to condensation. If this happens, remove the disc from the player and wait about an hour for the moisture to evaporate.

Damaged Disc

Do not attempt to play cracked, warped, or damaged discs. Playing a bad disc could severely damage the playback mechanism.

Maintenance

If you have problems, do not attempt to repair the unit yourself. Return it to your Alpine dealer or the nearest Alpine Service Station for servicing.

Never Attempt the Following

Do not grip or pull out the disc while it is being pulled back into the player by the automatic reloading mechanism.

Do not attempt to insert a disc into the unit when the unit power is off.

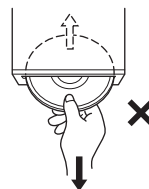

Inserting Discs

Your player accepts only one disc at a time for playback. Do not attempt to load more than one disc.

Make sure the label side is facing up when you insert the disc. "Error" will be displayed on your player if you insert a disc incorrectly. If "Error" continues to be displayed even though the disc has been inserted correctly, push the RESET switch with a pointed object such as a ballpoint pen.

Playing a disc while driving on a very bumpy road may result in skips, but this will not scratch the disc or damage the player.

New Discs

To prevent the CD from jamming, "Error" is displayed if discs with irregular surfaces are inserted or if discs are inserted incorrectly.

When a new disc is ejected immediately after initial loading, use your finger to feel around the inside of the center hole and outside edge of the disc. If you feel any small bumps or irregularities, this could inhibit proper loading of the disc. To remove the bumps, rub the inside edge of the hole and outside edge of the disc with a ballpoint pen or other such instrument, then insert the disc again.

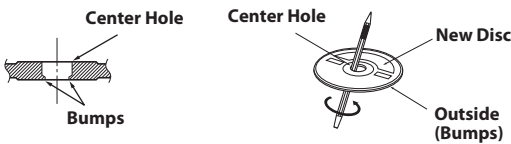

Irregular Shaped Discs

Be sure to use round discs only for this unit and never use any special shaped discs.

Use of anything but round discs may cause damage to the mechanism.



Installation Location

Make sure this unit will not be installed in a location subjected to:

- Direct sun and heat
- High humidity and water
- Excessive dust
- Excessive vibrations

Correct Handling

Do not drop the disc while handling. Hold the disc so you will not leave fingerprints on the surface. Do not affix tape, paper, or gummed labels to the disc. Do not write on the disc.

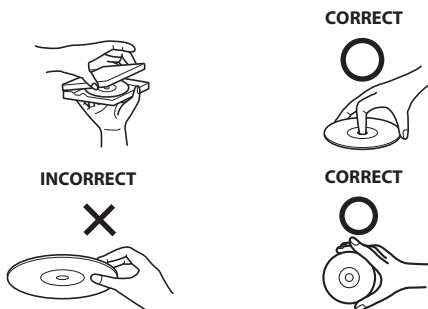

Disc Cleaning

Fingerprints, dust, or soil on the surface of the disc could cause the CD player to skip. For routine cleaning, wipe the playing surface with a clean, soft cloth from the center of the disc to the outer edge. If the surface is heavily soiled, dampen a clean, soft cloth in a solution of mild neutral detergent before cleaning the disc.



Disc Accessories

There are various accessories available on the market for protecting the disc surface and improving sound quality. However, most of them will influence the thickness and/or diameter of the disc. Using such accessories can cause the disc to be out of standard specifications and may create operational problems. We recommend not using these accessories on discs played in Alpine CD players.

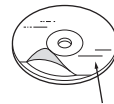

Transparent Sheet

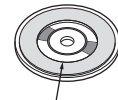

Disc Stabilizer

On handling Compact Discs (CD/CD-R/CD-RW)

- Do not touch the surface.
- Do not expose the disc to direct sunlight.
- Do not affix stickers or labels.
- Clean the disc when it is dusty.
- Make sure that there are no bumps around the disc.
- Do not use commercially available disc accessories.

Do not leave the disc in the car or the unit for a long time. Never expose the disc to direct sunlight. Heat and humidity may damage the CD and you may not be able to play it again.

To customers using CD-R/CD-RW

- If a CD-R/CD-RW cannot be played back, make sure the last recording session was closed (finalized).
- Finalize the CD-R/CD-RW if necessary, and attempt playback again.

About media that can be played

Use only compact discs with the label side showing the CD logo marks below.



If you use unspecified compact discs, correct performance cannot be guaranteed.

You can play CD-Rs (CD-Recordables)/CD-RWs (CD-ReWritables) which have been recorded only on audio devices. You can also play CD-Rs/CD-RWs containing MP3/WMA/AAC formatted audio files.

- Some of the following CDs may not play on this unit: Flawed CDs, CDs with fingerprints, CDs exposed to extreme temperatures or sunlight (e.g., left in the car or this unit), CDs recorded under unstable conditions, CDs on which a recording failed or a re-recording was attempted, copy-protected CDs which do not conform to the audio CD industry standard.

- Use discs with MP3/WMA/AAC files written in a format compatible with this unit. For details, refer to “About MP3/WMA/AAC” on page 15.
- ROM data other than audio files contained in a disc will not produce sound when played back.

Protecting the USB connector

- Only a Flash Memory or iPod/iPhone can be connected to the USB port on this unit. Correct performance using other USB products cannot be guaranteed.
- If the USB connector is used, be sure to use a USB extension cable (supplied). A USB hub is not supported.
- Depending on the connected Flash Memory device, the unit may not function or some functions may not be performed.
- The audio file format that can be played back on the unit is MP3/WMA/AAC.
- Artist/song name, etc., can be displayed. Certain, special characters may not be correctly displayed.

On Handling Flash Memory

CAUTION

Alpine accepts no responsibility for lost data, etc., even if data, etc. is lost while using this product.

- To prevent malfunction or damage, note the following points.
Read the Flash Memory Owner's Manual thoroughly.
Do not touch the terminals by hand or metal.
Do not subject Flash Memory to excessive shock.
Do not bend, drop, disassemble, modify or soak in water.
- Avoid usage or storage in the following locations:
Anywhere in the car exposed to direct sunlight or high temperatures.
Anywhere the possibility of high humidity or corrosive substances are present.
- Fix the Flash Memory in a location where driver operation will not be hindered.
- Flash Memory may not function correctly at high or low temperature.
- Use only certified Flash Memory. Pay attention that even certified Flash Memory, may not function correctly depending on its type or state.
- Flash Memory function is not guaranteed. Use Flash Memory according to the terms of agreement.
- Depending on the settings of the Flash Memory type, memory state or encoding software, the unit may not play back or display properly.
- A file that is copy-protected (copyright protection) cannot be played back.
- Flash Memory may take time to start playback. If there is a particular file other than audio in the Flash Memory, it may take considerable time before the file is played back or searched.
- The unit can play back “mp3”, “wma” or “m4a” file extensions.
- Do not add the above extensions to a file other than audio data. This non-audio data will not be recognized. The resulting playback may contain noise that can damage speakers and/or amplifiers.
- It is recommended to back up important data on a personal computer.
- Do not remove the USB device while playback is in progress. Change SOURCE to something other than USB, then remove the USB device to prevent possible damage to its memory.

- *Windows Media and the Windows logo are trademarks, or registered trademarks of Microsoft Corporation in the United States and/or other countries.*
- *iPhone, iPod, iPod classic, iPod nano, and iPod touch are trademarks of Apple Inc., registered in the U.S. and other countries.*
- *“Made for iPod,” and “Made for iPhone,” mean that an electronic accessory has been designed to connect specifically to iPod, or iPhone, respectively, and has been certified by the developer to meet Apple performance standards. Apple is not responsible for the operation of this device or its compliance with safety and regulatory standards. Please note that the use of this accessory with iPod, or iPhone may affect wireless performance.*
- *The BLUETOOTH® word mark and logos are registered trademarks owned by the Bluetooth SIG, Inc. and any use of such marks by Alpine Electronics, Inc. is under license. Other trademarks and trade names are those of their respective owners.*
- *MPEG Layer-3 audio coding technology licensed from Fraunhofer IIS and Thomson. Supply of this product only conveys a license for private, non-commercial use and does not convey a license nor imply any right to use this product in any commercial (i.e. revenue-generation) real time broadcasting (terrestrial, satellite, cable and/or any other media), broadcasting/streaming via internet, intranets and/or other networks or in other electronic content distribution systems, such as pay-audio or audio-on-demand applications. An independent license for such use is required. For details, please visit <http://www.mp3licensing.com>*
- *HD Radio Technology manufactured under license from iBiquity Digital Corporation. U.S. and Foreign Patents. HD Radio™ and the HD, HD Radio, and “Arc” logos are proprietary trademarks of iBiquity Digital Corp.*
- *Pandora, the Pandora logo, and the Pandora trade dress are trademarks or registered trademarks of Pandora Media, Inc., used with permission. Pandora is currently available exclusively in the United States.*
- *Sirius, XM and all related marks and logos are trademarks of Sirius XM Radio Inc. All rights reserved.*
- *Android is a trademark of Google Inc.*

Getting Started

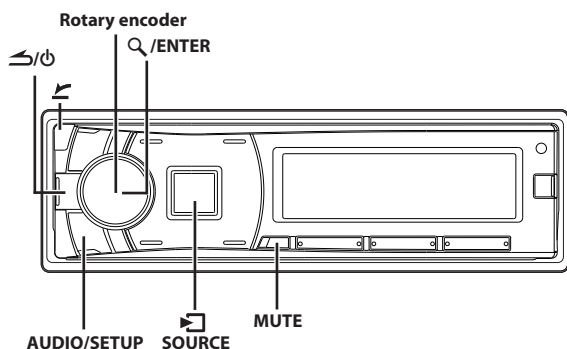

Accessory List

• Head unit	1
• Power cable.....	1
• USB extension cable.....	1
• Microphone	1
• Mounting sleeve.....	1
• Carrying case	1
• Bracket Key	2
• Screw (M5 × 8)	4
• Owner's Manual.....	1 set

Turning Power On and Off

Press to turn on the unit.

Notes

- The unit can be turned on by pressing any other button except .
- /SOURCE key blinks each time the unit is powered on.

Press and hold for at least 2 seconds to turn off the unit.

Note

- The first time power is turned on, the volume will start from level 12.

Source Selection

Press /SOURCE to change the source.

HD Radio → SiriusXM*1 → Disc → USB/iPod*2 →
BLUETOOTH Audio*3 → PANDORA*4 → Auxiliary*5 → HD Radio

- *1 Displayed only when a SiriusXM Tuner is connected.
- *2 Displayed only when the iPod/iPhone is connected.
- *3 Displayed only when Bluetooth IN is set to ON, refer to "Setting the BLUETOOTH Connection (Bluetooth IN)" on page 30.
- *4 Not displayed when Alpine APP is set to OFF, refer to "Setting the communication mode with a Smartphone (Alpine APP)" on page 28.
- *5 Displayed only when the AUX IN is set to ON, refer to "Setting the AUX SETUP mode" on page 26.

Detaching and Attaching the Front Panel

Detaching

- 1 Turn off the unit power.
- 2 Press (OPEN) to open the front panel (figure 1).
To close the front panel, press the left side until it locks as shown in the figure 2.

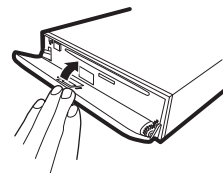
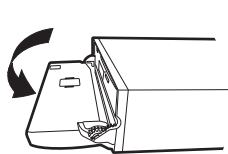

- 3 Grasp the front panel firmly, slide to the left , and then pull to remove.

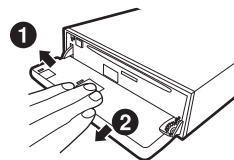

Notes

- The front panel may become hot in normal usage (especially the connector terminals on the back of the front panel). This is not a malfunction.
- To protect the front panel, place it in the supplied carrying case.
- When detaching the front panel, do not apply excessive force as it may result in malfunction.
- Do not leave the front panel open, or drive the car with the panel open as it may result in an accident or malfunction.

Attaching

- 1 Insert the right side of the front panel into the main unit. Align the groove on the front panel with the projections on the main unit.
- 2 Push the left side of the front panel until it locks firmly into the main unit.

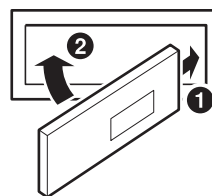

Notes

- Before attaching the front panel, make sure that there is no dirt or dust on the connector terminals and no foreign object between the front panel and the main unit.
- Attach the front panel carefully, holding the sides of the front panel to avoid pushing buttons by mistake.

Initial System Start-Up

Be sure to press the RESET switch when using the unit for the first time, after changing the car battery, etc.

- 1 Turn off the unit power.
- 2 Press **OPEN** to open the front panel, and then remove it.
- 3 Press **RESET** with a ballpoint pen or similar pointed object.

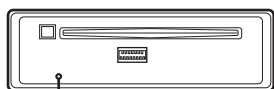

RESET switch

Adjusting Volume

Turn the **Rotary encoder** until the desired sound is obtained.

Lowering Volume Quickly

Activating the Audio Mute function will instantly lower the volume level by 20 dB.

- 1 Press **MUTE** to activate the **MUTE** mode.
The audio level will decrease by about 20 dB.
- 2 Pressing **MUTE** again will bring the audio back to its previous level.

Setting the Time and Calendar

- 1 Press and hold **AUDIO/SETUP** for at least 2 seconds to activate the **SETUP** selection mode.
- 2 Turn the **Rotary encoder** to select the **General** mode, and then press **Q/ENTER**.
- 3 Turn the **Rotary encoder** to select **Clock Adjust**, and then press **Q/ENTER**.
- 4 Turn the **Rotary encoder** to set year.
- 5 Press **Q/ENTER**.
- 6 Repeat steps 4 and 5 above to set month, date, hour and minute.
- 7 Press and hold **AUDIO/SETUP** for at least 2 seconds to return to normal mode.

Notes

- Pressing **↩** returns to the previous **SETUP** mode.
- If no operation is performed for 60 seconds, **SETUP** is canceled.

- To synchronise the clock to another clock/watch or radio time announcement, press and hold **Q/ENTER** for at least 2 seconds after setting the "hour". Minutes will reset to 00. If the display shows over "30" minutes when you do this, the time will advance one hour.

Controllable with Remote Control

This unit can be controlled with an optional Alpine remote control. For details, consult your Alpine dealer. Point the optional remote control transmitter at the remote-control sensor.

Remote control sensor

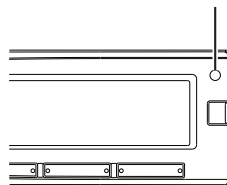

Connectable to Remote Control Interface Box

With an optional Alpine Steering Wheel Remote Control Interface Box, this unit is controllable from the vehicle's steering wheel controls. For details, contact your Alpine dealer.

HD Radio™ Reception

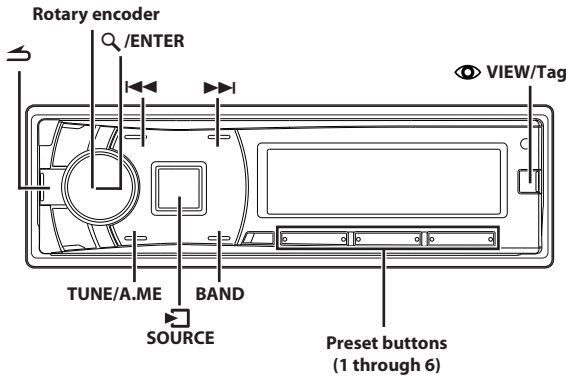

This unit is able to receive signals based on the terrestrial digital radio broadcasting standard.

When current AM/FM broadcasters are transmitting digital audio and data services, HD Radio signals are on-the-air in their service area. You can receive their digital broadcast and enjoy high quality sound. Depending on the Listen Mode setting, this unit will tune to either the Digital or Analog signals. For details, please refer to "Switching the listening mode" on page 27.

While receiving a live, HD Radio broadcast, you can switch to either the Digital or Analog signal for listening. For details, refer to "Setting the Live mode (Live Mode)" on page 27.

Listening to Radio

- 1 Press **SOURCE** to select HD Radio mode.
- 2 Press **BAND** repeatedly until the desired radio band is displayed.
FM1 → FM2 → AM → FM1
- 3 Press **TUNE/A.ME** to select the tuning mode.
DX (Distance mode) → LOCAL (Local mode) →
MANUAL (Manual mode) → DX
Note
 - The initial mode is Distance mode.**Distance mode:**
Both strong and weak stations will be automatically tuned in (Automatic Seek Tuning).
Local mode:
Only strong stations will be automatically tuned in (Automatic Seek Tuning).
Manual mode:
The frequency is manually tuned in steps (Manual tuning).
- 4 Press **◀◀** or **▶▶** to tune in the desired station.
Holding down **◀◀** or **▶▶** will change the frequency continuously.

Note

- If SEEK type is set to Digital, only Digital HD Radio stations are found using the SEEK UP/DOWN function. Refer to "Setting the Digital Seek" on page 27.

Presetting Stations Manually

- 1 Select the radio band and tune in a desired radio station you wish to store in the preset memory.
- 2 Press and hold, for at least 2 seconds, any one of the **preset buttons (1 through 6)** into which you wish to store the station.
The selected station is stored.
The display shows the band, preset number and station frequency memorized.

Notes

- A total of 18 stations can be stored in the preset memory (6 stations for each band; FM1, FM2 and AM).
- If you store a station in a preset memory which already has a station, the current station will be cleared and replaced with the new station.

Presetting Stations Automatically

- 1 Press **BAND** repeatedly until the desired radio band is displayed.
- 2 Press and hold **TUNE/A.ME** for at least 2 seconds.
The tuner will automatically seek and store 6 strong stations in the selected band. They will be stored into preset buttons 1 to 6 in order of signal strength.
When the automatic memory has been completed, the tuner goes to the station stored in preset location No.1.

Notes

- If no stations are stored, the tuner returns to the station you were listening to before the auto memory procedure began.
- Sub-program service of Multicast stations are not included in the automatic memory search.

Tuning to Preset Stations

- 1 Press **BAND** repeatedly until the desired band is displayed.
- 2 Press any one of the **station preset buttons (1 through 6)** that has your desired radio station in memory.
The display shows the band, preset number and frequency of the station selected.

Note

- If the digital signal for any service becomes weak, none of the digital features are available. For example, a Multicast channel recalled from preset memory will revert to the Main Program Service with loss of the digital signal ("Signal Loss" is displayed). Upon return of the digital signal strength, the tuner will resume playback of the Multicast channel.

Frequency Search Function

You can search for a radio station by its frequency.

- 1 Press **Q/ENTER** in Radio mode to activate the search mode.
- 2 Turn the **Rotary encoder** to select "Frequency SEARCH", and then press **Q/ENTER** to enter the frequency search mode.*
 - * Operation is not required when Listen Mode is set to Analog (refer to "Switching the listening mode" on page 27).
- 3 Turn the **Rotary encoder** to select the desired frequency.
- 4 Press **Q/ENTER** to receive the selected frequency.

Note

- Press **↵** in the search mode to cancel. Or, the search mode will be canceled if no operation is performed for 60 seconds.

Receiving a Multicast Station

Multicasting is the Ability to broadcast multiple program streams over a single FM frequency. This increases the amount and diversity of content choices. A maximum of eight multicast station channels can be selected on this unit.

Note

- Make sure Listen Mode is set to other than Analog (refer to "Switching the listening mode" on page 27).

When multicast station is received, the program number and the Multicast indicator lights up. Press ◀◀ or ▶▶ to select the desired program service.*

Receiving the Multicast Station Program Service.

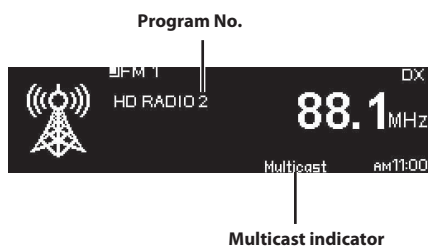

Program Service example:

Multicast Radio Station	Program No.	Program Service
88.1 MHz	1	Main Program Service
88.1 MHz	2	Sub-program Service
88.1 MHz	3	Sub-program Service
88.1 MHz	8	Sub-program Service

- * This operation can be performed only when Multi Cast Seek is set to ON (refer to "Setting the Multicast Seek" on page 27).

Multicast Station Search

If a frequency has a Multicast station broadcast, the Multicast indicator lights up. Use the Multicast search mode to select a desired program from the Multicast stations available.

Note

- Make sure Listen Mode is set to other than Analog (refer to "Switching the listening mode" on page 27).

- 1 Choose a frequency with the Multicast indicator on.
- 2 Press **Q/ENTER** to activate the search mode.
- 3 Turn the **Rotary encoder** to select Multi Cast Search, and then press **Q/ENTER** to enter the Multicast search mode.
- 4 Turn the **Rotary encoder** to select the desired station, and then press **Q/ENTER**. The selected station is received.

Notes

- Press **VIEW** at step 4. You can change the display between station name, song name, artist name and program type.
- The search mode will be canceled if no operation is performed for 60 seconds.

Storing the tag information

iTunes Tagging lets you tag songs heard on HD Radio stations. You can preview, buy and download later, songs from your iTunes tagged playlist the next time you sync your iPod/iPhone. If the unit is connected to a Tagging compatible iPod/iPhone, you can use the iTunes Tagging function. For details, refer to the Owner's Manual of the Tagging compatible iPod/iPhone.

The **Tag** indicator will light when a song playing on an HD Radio station has tag information available.

Press and hold **VIEW/Tag to save its tag information.**

If no iPod/iPhone is connected, "Tag Count X" is displayed (X is the total amount of the tag information stored in this unit).

Notes

- During tagging, the iPod/iPhone takes priority to save the tag information. If no iPod/iPhone is connected, the tag information is saved to this unit.
- When the memory of iPod/iPhone is full, "iPod Full" and "Tag Count X" are displayed. The tag information will be stored to the unit.
- If the operation is failed, "Cannot Tag" is displayed.
- This unit can store up to 50 pieces of tag information. When the memory of the unit is full, "Tag Count50" and "Memory Full" may be displayed.
- When an iPod that doesn't support the tagging function is connected, "Non-Tagging iPod" may be displayed.
- When the iPod/iPhone is disconnected from the unit during tagging, its tag information will be stored in the unit.
- If there is stored tag information on the unit, when an iPod/iPhone supporting the tag function is connected, the stored tag information will be transferred to the iPod/iPhone automatically. When the iPod/iPhone memory becomes full, "iPod Full" will be displayed, and any remaining tag information on the unit will not be transferred to the iPod/iPhone.
- If tag information already exists, "Already Tagged" will be displayed when you try to tag information again.

About the Feature Logos

Digital Sound

- Digital, CD-quality sound. HD Radio Technology enables local radio stations to broadcast a clean digital signal. AM sounds like today's FM and FM sounds like a CD.

PSD

- Program Service Data: Contributes to the superior user experience of HD Radio Technology. Presents song name, artist, station IDs, HD2/HD3 Channel Guide, and other relevant data streams.

HD2/HD3

- Adjacent to traditional main stations are extra local FM channels. These HD2/HD3 Channels provide new, original music as well as deep cuts into traditional genre.

iTunes® Tagging

- iTunes® Tagging provides you the opportunity to discover a wide range of content and the means to “tag” that content for later review and purchase from the iTunes® Store.

CD/MP3/WMA/AAC

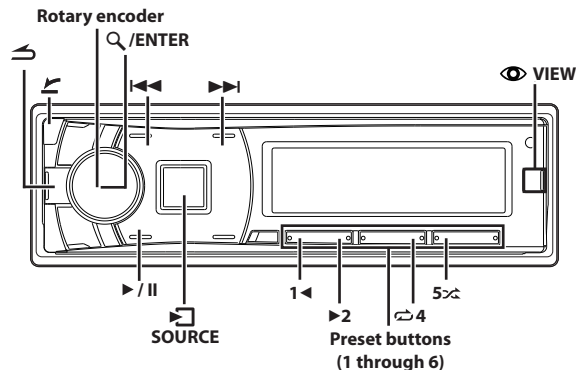

Playback

- 1 Press **Q/ENTER** (OPEN).
The front panel will open.
- 2 Insert a disc with the label side facing up.
The disc will be pulled into the unit automatically.

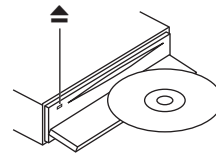

- 3 Close the front panel manually.
Note
 - When a disc is already inserted, press **SOURCE** to switch to the Disc mode.
- 4 While playing back MP3/WMA/AAC, press **1** ◀ or ▶ **2** to select the desired folder.
Pressing and holding **1** ◀ or ▶ **2** will change folders continuously.
- 5 Press **I◀◀** or ▶▶**I** to select the desired track (file).
Pressing and holding **I◀◀** or ▶▶**I** will fast backward/fast forward track continuously.
- 6 To pause playback, press **P/II**.
Pressing **P/II** again will resume playback.
- 7 After pressing **Q/ENTER** (OPEN) to open the front panel, press **▲** to eject the disc.

Notes

- Do not remove a CD during its eject cycle. Do not load more than one disc at a time. A malfunction may result from doing either.
- Three-inch (8 cm) CDs cannot be used.
- Any file protected by DRM (Digital Rights Management) copy protection, cannot be played back on this unit.
- The track display for MP3/WMA/AAC data playback is the file numbers recorded on the disc.

- The playback time may not be correctly displayed when a VBR (Variable Bit Rate) recorded file is played back.
- Press **VIEW** to switch the display. For details, refer to “Displaying the Text” on page 22.

Repeat Play

- 1 Press **4**.
The song is played back repeatedly.
RPT*1 → RPT **2** → (off) → RPT
*1 Only a track/file is repeatedly played back.
*2 Only files in a folder are repeatedly played back (MP3/WMA/AAC mode only).
- 2 To cancel repeat play, select (off) with the above procedure.

M.I.X. (Random Play)

- 1 Press **5** **↔**.
The songs are played back in random sequence.
MIX **2** → MIX ALL*2 → (off) → MIX **2**
*1 Only files in a folder are played back in random sequence (MP3/WMA/AAC mode only).
*2 The tracks/files are played back in random sequence.
- 2 To cancel M.I.X. play, select (off) with the above procedure.

Searching for CD Text

On discs utilizing CD Text, songs can be searched and played by using their recorded titles. For discs without CD Text, searches are made using the track numbers associated with each song.

- 1 Press **Q/ENTER** during play.
This will set the search mode.
- 2 Turn the **Rotary encoder** to select the desired track, and then press **Q/ENTER**.
This will play the selected track.

Notes

- Press **↔** in the search mode to cancel. Or, the search mode is canceled if no operation is performed for 60 seconds.
- When CD Text Search is made during M.I.X. play, the M.I.X. play mode will be canceled.
- If any one of the **preset buttons (1 through 6)** is pressed in the search mode, a search can be made quickly by skipping to the specified location. For details, refer to “Direct Search Function” on page 38.

Folder/File Name Search (Concerning MP3/WMA/AAC)

Folder and file names may be searched and displayed during playback.

Folder Name Search mode

- 1 During MP3/WMA/AAC playback, press **Q/ENTER** to activate the search mode.
- 2 Turn the **Rotary encoder** to select Folder Name Search mode, and then press **Q/ENTER**.
- 3 Turn the **Rotary encoder** to select the desired folder.
- 4 Press and hold **Q/ENTER** for at least 2 seconds to play back the first file in the selected folder.

Notes

- If no operation is performed for 60 seconds, the search mode is canceled.
- Press **↔** in the search mode to return to the previous mode.
- To search for files in the Folder Name Search mode, press **Q/ENTER**. Files in the folder may be searched.
- Press **↔** to exit Folder Name Search mode in step 3 in order to select File Name Search mode.
- When Folder Name Search is made during M.I.X. play, the M.I.X. play mode will be canceled.
- The root folder of a disc is displayed as “\ROOT”.
- If any one of the **preset buttons (1 through 6)** is pressed in the search mode, a search can be made quickly by skipping to the specified location. For details, refer to “Direct Search Function” on page 38.

File Name Search mode

- 1 During MP3/WMA/AAC playback, press **Q/ENTER** to activate the search mode.
- 2 Turn the **Rotary encoder** to select File Name Search mode, and then press **Q/ENTER**.
- 3 Select the desired file by turning the **Rotary encoder**.
- 4 Press **Q/ENTER** to play back the selected file.

Notes

- If no operation is performed for 60 seconds, the search mode is canceled.
- Press **↔** in the search mode to return to the previous mode.
- When File Name Search is made during M.I.X. play, the M.I.X. play mode will be canceled.
- If any one of the **preset buttons (1 through 6)** is pressed in the search mode, a search can be made quickly by skipping to the specified location. For details, refer to “Direct Search Function” on page 38.

Search Position Memory

During playback, you can quickly return to the last-selected hierarchy level in the search mode.

Press **↔**.

The hierarchy you selected last in the search mode is displayed.

About MP3/WMA/AAC

⚠ CAUTION

Except for private use, duplicating audio data (including MP3/WMA/AAC data) or distributing, transferring, or copying it, whether for free or for a fee, without permission of the copyright holder is strictly prohibited by the Copyright Act and by international treaty.

What is MP3?

MP3, whose official name is "MPEG Audio Layer 3," is a compression standard prescribed by the ISO, the International Standardization Organization and MPEG which is a joint activity institution of the IEC. MP3 files contain compressed audio data. MP3 encoding is capable of compressing audio data at extremely high ratios, reducing the size of music files to as much as one-tenth their original size. This is achieved while still maintaining near CD quality. The MP3 format realizes such high compression ratios by eliminating the sounds that are either inaudible to the human ear or masked by other sounds.

What is WMA?

WMA, or "Windows Media™ Audio," is compressed audio data. WMA is similar to MP3 audio data.

What is AAC?

AAC is the abbreviation for "Advanced Audio Coding", and is a basic format of audio compression used by MPEG2 or MPEG4.

Method for creating MP3/WMA/AAC files

Audio data is compressed using software with MP3/WMA/AAC codecs. For details on creating MP3/WMA/AAC files, refer to the user's manual for that software.

MP3/WMA/AAC files that are playable on this device have the file extensions "mp3"/"wma"/"m4a". Files with no extension cannot be played back (WMA ver. 7, 8 and 9 are supported). Protected files are not supported, neither are raw AAC files (using the ".aac" extension). There are many different versions of the AAC format. Confirm that the software being used conforms to the acceptable formats listed above. It's possible that the format may be unplayable even though the extension is valid.

Playback of AAC files encoded by iTunes is supported.

Supported playback sampling rates and bit rates

MP3

Sampling rates: 48 kHz, 44.1 kHz, 32 kHz, 24 kHz, 22.05 kHz, 16 kHz, 12 kHz, 11.025 kHz, 8 kHz

Bit rates: 8 - 320 kbps

WMA

Sampling rates: 48 kHz, 44.1 kHz, 32 kHz

Bit rates: 32 - 192 kbps

AAC

Sampling rates: 48 kHz, 44.1 kHz, 32 kHz, 24 kHz, 22.05 kHz, 16 kHz, 12 kHz, 11.025 kHz, 8 kHz

Bit rates: 16 - 320 kbps

This device may not play back correctly depending on sampling rates. In the USB mode, the playback time may not be correctly displayed when a VBR (Variable Bit Rate) recorded file is played back.

ID3 tags/WMA tags

This device supports ID3 tag v1 and v2, and WMA/AAC tag.

If tag data is in an MP3/WMA/AAC file, this device can display the title (track title), artist name, and album name ID3 tag/WMA/AAC tag data. This device can only display single-byte alphanumeric characters (up to 32 for ID3 tags and up to 32 for WMA tags) and the underscore. For non-supported characters, "No Support" is displayed or the character is displayed as space.

If information contains characters other than ID3 tag information, the audio file may not be played back.

The tag information may not be correctly displayed, depending on the contents.

Playing back MP3/WMA/AAC

MP3/WMA/AAC files are prepared, then written to a CD-R, CD-RW using CD-R writing software or stored to a Flash Memory. A disc can hold up to 509 files/folders (including Root Folders), and the maximum number of folders is 255.

Playback may not be performed if a disc exceeds the limitations described above.

Media supported

The media that this device can play back are CD-ROMs, CD-Rs, and CD-RWs.

This device also can play back Flash Memory media.

Corresponding File Systems

This device supports discs formatted with ISO9660 Level 1 or Level 2. Under the ISO9660 standard, there are some restrictions to remember. The maximum nested folder depth is 8 (including the root directory). The number of characters for a folder/file name is limited.

Valid characters for folder/file names are letters A-Z (all caps), numbers 0-9, and '_' (underscore).

This device also can play back discs in Joliet, Romeo, etc., and other standards that conform to ISO9660. However, sometimes the file names, folder names, etc., are not displayed correctly.

This device also supports FAT 12/16/32 for Flash Memory device.

Formats supported

This device supports CD-ROM XA, Mixed Mode CD, Enhanced CD (CD-Extra) and Multi-Session.

This device cannot correctly play back discs recorded with Track At Once or packet writing.

Order of files

Files are played back in the order that the writing software writes them to the disc. Therefore, the playback order may not be what is expected. Verify the writing order in the software's documentation. The playback order of the folders and files is as follows.

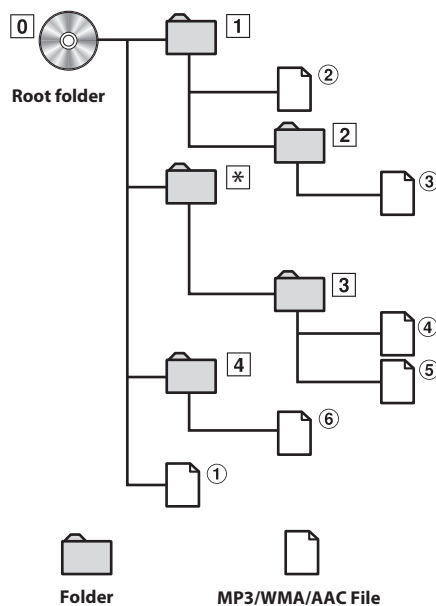

* The folder No./ folder Name will not be displayed if no file is contained in the folder.

Terminology

Bit rate

This is the “sound” compression rate specified for encoding. The higher the bit rate, the higher the sound quality, but also the larger the files.

Sampling rate

This value shows how many times per second the data is sampled (recorded). For example, music CDs use a sampling rate of 44.1 kHz, so the sound is sampled (recorded) 44,100 times per second. The higher the sampling rate, the higher the sound quality, but also the larger the volume of data.

Encoding

Converting music CDs, WAVE (AIFF) files, and other sound files into the specified audio compression format.

Tag

Song information such as track titles, artist names, album names, etc., written into MP3/WMA/AAC files.

Root folder

The root folder (or root directory) is found at the top of the file system. The root folder contains all folders and files. It is created automatically for all burned discs.

Sound Setting

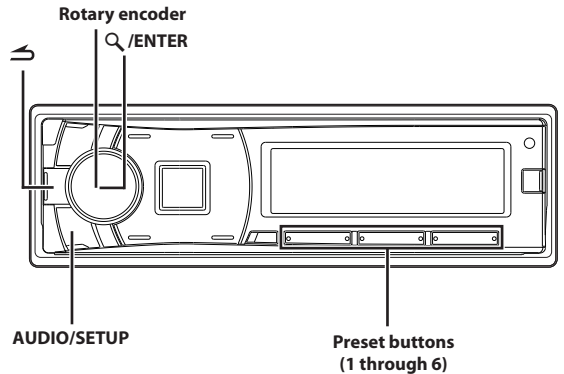

Adjusting Subwoofer Level/Bass Level/ Treble Level/Balance (Between Left and Right)/Fader (Between Front and Rear)/ Defeat

1 Press **AUDIO** repeatedly to choose the desired mode.

Each press changes the mode as follows:

SubW LEVEL*1 → BASS*2 → TREBLE*2 → BALANCE → FADER → DEFEAT → VOLUME → SubW LEVEL

*1 When the Subwoofer mode is set to OFF, its level cannot be adjusted, refer to “Turning Subwoofer ON/OFF” on page 18.

*2 Adjustable only when DEFEAT is OFF.

Subwoofer Level	0 ~ 15
Bass level	-7 ~ 7
Treble level	-7 ~ 7
Balance	-15(L) ~ 15(R)
Fader	-15(R) ~ 15(F)
Defeat	ON/OFF
Volume	0 ~ 35

Note

- If no operation is performed for 5 seconds after selecting the SubW LEVEL, BASS, TREBLE, BALANCE, FADER, DEFEAT or VOLUME mode, the unit automatically returns to normal mode.

2 Turn the **Rotary encoder** until the desired sound is obtained in each mode.

Note

- By setting DEFEAT ON, previously adjusted level settings of BASS and TREBLE will return to the factory defaults.

Audio Setup

You can flexibly customize the unit to suit your own preference and usage. From the AUDIO SETUP menu, Audio Setting can be modified.

Use steps 1 to 5 to select the category you wish to modify. For details on how to change each setting, see the following sections below.

- 1 Press and hold **AUDIO/SETUP** for at least 2 seconds to activate the **SETUP** mode.
- 2 Turn the **Rotary encoder** to select **Audio**, and then press **Q/ENTER**.
Audio*¹ ↔ General ↔ Display ↔ Tuner ↔ SiriusXM*² ↔ iPod&USB ↔ Application ↔ Bluetooth ↔ Audio
**1 Adjustment cannot be performed during a call.
2 Displayed only when a SiriusXM Tuner is connected.
- 3 Turn the **Rotary encoder** to select the desired **sound setting menu**, and then press **Q/ENTER**.
Factory's EQ*^{3/4} ↔ Parametric EQ*^{3/5} ↔ VOL LV ADJ ↔ Subwoofer ↔ Subwoofer Phase*⁶ ↔ Subwoofer System*⁶ ↔ Power IC ↔ MX Setup*³ ↔ TCR Parameter*³ ↔ T.Correction*³ ↔ Spatial*³ ↔ X-Over*³ ↔ Factory's EQ
**3 Adjustment cannot be performed when DEFEAT is set to ON.
*4 Any changes made to either Factory's EQ or Parametric EQ are reflected in the others' settings.
*5 In step 3, nine sound adjustment items can be selected in Parametric EQ mode. Turn the **Rotary encoder** to select the desired item, and then press **Q/ENTER** to continue to step 4.
6 These functions are inoperable when Subwoofer is set to OFF.
- 4 Turn the **Rotary encoder** to change the setting, and then press **Q/ENTER**.
- 5 Press and hold **AUDIO/SETUP** for at least 2 seconds to return to normal mode.

Notes

- Pressing **↩** returns to the previous Sound menu mode.
- If no operation is performed for 60 seconds, Sound menu mode is canceled.

Equalizer Presets (Factory's EQ)

10 typical equalizer settings are preset at the factory for a variety of musical source material. User settings are created in the Parametric EQ mode.

User ↔ Flat (Initial setting) ↔ Pops ↔ Rock ↔ News ↔ Jazz&Blues ↔ Electrical Dance ↔ Hip Hop&Rap ↔ Easy Listening ↔ Country ↔ Classical

Note

- The 9-Band, Parametric EQ is used to create the Factory EQ settings.

Adjusting the Parametric Equalizer Curve (Parametric EQ)

You can modify the Equalizer settings to create a response curve more appealing to your personal taste.

- 1 After selecting **Parametric EQ** from the Audio Setup mode, turn the **Rotary encoder** to select the desired band, then press **Q/ENTER**.

- 2 Turn the **Rotary encoder** to select the desired frequency within the selected band, then press **Q/ENTER**.
- 3 Repeat step 2 to adjust the **Bandwidth and Level** within the selected band.

Adjusting the Band

Setting contents:

Band1/Band2/Band3/Band4/Band5/Band6/Band7/Band8/
Band9

Adjusting the Frequency (Freq.)

Adjustable frequency bands: 20 Hz to 20 kHz

Band1:	20 Hz ~ 100 Hz (63 Hz)
Band2:	63 Hz ~ 315 Hz (125 Hz)
Band3:	125 Hz ~ 500Hz (250 Hz)
Band4:	250 Hz ~ 1 kHz (500 Hz)
Band5:	500 Hz ~ 2 kHz (1 kHz)
Band6:	1 kHz ~ 4 kHz (2 kHz)
Band7:	2 kHz ~ 7.2 kHz (4 kHz)
Band8:	5.8 kHz ~ 12 kHz (8 kHz)
Band9:	9 kHz ~ 20 kHz (16 kHz)

Setting the Bandwidth (Q)

Setting contents:

3.0 (Initial setting) / 4.0 / 5.0

Notes

- Settings exceeding the frequency of adjacent bands are not available.
- While adjusting the Parametric EQ, you should consider the frequency response of the connected speakers.
- When the Parametric EQ is adjusted, the adjustment for Factory's EQ becomes ineffective.
- The Parametric EQ setting can be configured when Defeat is OFF.

Adjusting the Level

Setting contents:

-7 to +7 (Initial setting: 0)

Note

- Band2 and Band8 are the same as the Bass and Treble controls. Their Level adjustment can also be controlled by pressing **AUDIO** and selecting Bass Level or Treble Level. Refer to "Adjusting Subwoofer Level/Bass Level/Treble Level/Balance (Between Left and Right)/Fader (Between Front and Rear)/Defeat" on page 16.
- Settings exceeding the frequency of adjacent bands are not available.
- While adjusting the Parametric EQ, you should consider the frequency response of the connected speakers.
- The Parametric EQ is used to create the Factory's EQ settings.

Setting the Source Volume Level

The output level of each source is individually adjustable. For example, if the Tuner level sounds lower than Disc, its output can be adjusted without affecting the other sources.

■ **Setting item:** VOL LV ADJ

■ **Further setting items:** Tuner / SiriusXM / Disc / USB / iPod / BT Audio / Pandora / AUX

Setting contents:

-14 dB ~ +14 dB

Turning Subwoofer ON/OFF

When the subwoofer is on, you can adjust the subwoofer output level (refer to “Adjusting Subwoofer Level/Bass Level/Treble Level/Balance (Between Left and Right)/Fader (Between Front and Rear)/Defeat” on page 16).

Setting item: Subwoofer

Setting contents:

OFF / ON (Initial setting)

OFF:

No subwoofer signal is output from the Subwoofer RCA Connectors (refer to “Connections” on page 54).

ON:

The subwoofer signal is output from the Subwoofer RCA Connectors (refer to “Connections” on page 54).

Setting the Subwoofer Phase

The subwoofer output phase is toggled Subwoofer Normal (0°) or Subwoofer Reverse (180°). To adjust the level, turn the **Rotary encoder**.

Setting item: Subwoofer Phase

Setting contents:

0° (Initial setting) / 180°

Setting the Subwoofer System

When the subwoofer is on, you can select either System 1 or System 2 for the desired subwoofer effect.

Setting item: Subwoofer System

Setting contents:

System 1/ System 2 (Initial setting)

System 1:

Subwoofer level changes according to the main volume setting.

System 2:

Subwoofer level change is different from the main volume setting. For example, even at low volume settings, the subwoofer is still audible.

External Device

Connecting to an External Amplifier

When an external amplifier is connected, sound quality can be improved by stopping the power supply of the built-in amplifier.

Setting item: Power IC

Setting contents:

OFF / ON (Initial setting)

OFF:

Use this mode when the line output of this unit is used to drive an external amplifier. In this setting, the head unit’s internal amplifier is turned OFF and can not drive speakers.

ON:

The speakers are driven by the built-in amplifier.

OFF:

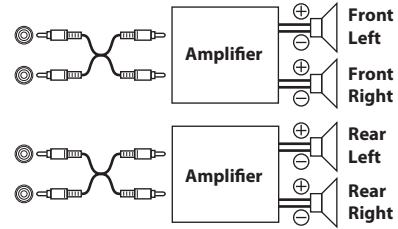

ON:

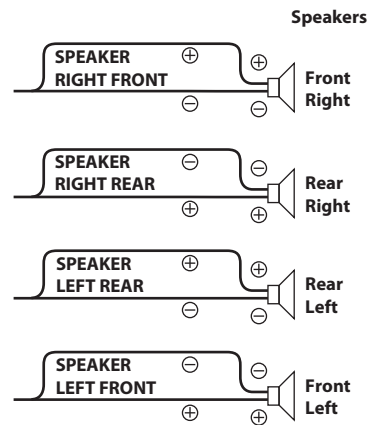

Note

- No sound is produced by the system when the Power IC is set to OFF.

Setting the Media Xpander mode (MX Setup)

MX (Media Xpander) makes vocals or instruments sound distinct regardless of the music source. The CD and iPod, etc. will be able to reproduce the music clearly even in cars with a lot of road noise.

Setting item: MX Setup

- Turn the **Rotary encoder** to select the source to which you want to apply Media Xpander, and then press **Q/ENTER**.

Analog Tuner ↔ HD1 ↔ HD2 ↔ HD3&Other ↔ SiriusXM ↔ CD ↔ CPM™ ↔ USB ↔ iPod ↔ BT Audio ↔ Pandora ↔ AUX

* Be applied for MP3/WMA/AAC files in disc.

- Turn the **Rotary encoder** to select the Media Xpander level, and then press **Q/ENTER**.

OFF ↔ Level 1 ↔ Level 2 ↔ Level 3 ↔ Customize

Customizing the Media Xpander setting

If Customize is selected in step 2, you can modify the Media Xpander to suit your personal preference.

- Turn the **Rotary encoder** to select the Band, and then press **Q/ENTER**. Band1 (Low frequencies) → Band3 (High frequencies)

Band1 (Bass) ↔ Band2 (Mid) ↔ Band3 (High)

- Turn the **Rotary encoder** to adjust the level, and then press **Q/ENTER**.

LEVEL: 0 ~ 8

5 Repeat steps 3 to 4 to complete the setting of other bands.

Setting the Time Correction Unit (TCR Parameter)

You can change the unit, (cm or inch) of time correction.

■ **Setting item:** TCR Parameter

Setting contents:

cm (Initial setting) / inch

cm:

Time correction value is in centimetres.

inch:

Time correction value is in inches.

Adjusting the Time Correction (T.Correction)

Before performing the following procedures, refer to "About Time Correction" on page 20.

1 After selecting T.Correction from the Audio Setup mode, turn the Rotary encoder to select a speaker to be adjusted, and then press \mathcal{Q} / ENTER.

F-L*1 \leftrightarrow F-R*2 \leftrightarrow R-L*3 \leftrightarrow R-R*4 \leftrightarrow SW-L \leftrightarrow SW-R

*1 Front-L

*2 Front -R

*3 Rear-L

*4 Rear-R

2 Turn the Rotary encoder to adjust the distance of the selected speaker, and then press \mathcal{Q} / ENTER.

0.0 cm to 336.6 cm (3.4 cm/step)

0.0 inch to 132.7 inch (1.3 inch/step)

Note

- The total adjustment distance for all speakers should be less than 510 centimeters (201 inches).

3 Repeat steps 1 and 2 to set another speaker.

By setting these values to make its sound reach the listening position at the same time as the sound of other speakers.

Adjusting SPATIAL

This function allows you to change the sound field easily. There are three modes to choose from. For details, refer to the table below.

Mode	Effect
OFF (Initial setting)	No effect is applied. OFF status
Front Wide	Creates the effect of widening the front sound field by delaying the sound of the front speakers.
Rear Wide	Creates the effect of making the front sound image clear and far by delaying the sound of the rear speakers.

Adjusting the Crossover Settings (X-Over)

Before performing the following procedures, refer to "About the Crossover" on page 21.

1 After selecting X-Over from the Audio Setup mode, turn the Rotary encoder to select the desired channel, then press \mathcal{Q} / ENTER.

2 Turn the Rotary encoder to select the desired frequency within the selected channel, then press \mathcal{Q} / ENTER.

3 Repeat step 2 to adjust the Slope and Level within the selected channel.

Adjusting the Channel (Ch.)

Setting contents:

Front (HPF) / Rear (HPF) / SUBW (LPF)

Selecting the Cut-Off Frequency (Freq.)

Setting contents:

20 / 25 / 31.5 / 40 / 50 / 63 / 80 (Initial setting) / 100 / 125 / 160 / 200 (Hz)

Adjusting the Slope

Setting contents:

Flat (Initial setting) / 6 / 12 / 18 / 24 dB/oct.

Adjusting the Level (Lev.)

Setting contents:

-12 to 0 (dB) (Initial setting: 0)

4 Repeat steps 1 to 2 to make adjustment to the other channels.

Storing the Parametric EQ/T.Correction/X-Over Settings

The Parametric EQ/T.Correction and X-Over settings can be stored in the preset memory.

1 The Parametric EQ/T.Correction/X-OVER settings can be stored in any one of the preset buttons (1 through 6). After completing any adjustment for Parametric EQ/T.Correction/X-OVER (e.g. BAND), press and hold the desired preset button for at least 2 seconds.

2 Turn the Rotary encoder to select Protect YES/NO, and then press \mathcal{Q} / ENTER to store the adjusted contents.
Protect NO \leftrightarrow Protect YES (Initial setting)

Notes

- If Protect YES is selected, the adjusted contents are protected and stored into the preset buttons. When you want to store the parameter into a protected preset button, "Replace NO/YES" can be selected. If Protect NO is selected, the preset is stored.
- While perform this operation, all adjusted contents of Parametric EQ/T.Correction and X-Over will be stored in the preset buttons.
- The stored contents are not deleted even when resetting the unit or disconnecting the battery.
- The stored contents can be recalled by performing operation (refer to "Recalling the Stored Parametric EQ/T.Correction/X-Over Settings" on page 20).

Recalling the Stored Parametric EQ/ T.Correction/X-Over Settings

The stored Parametric EQ/T.Correction and X-Over settings are in the preset memory.

- 1 After selecting any item of the Parametric EQ/T.Correction/X-Over mode (e.g. Band), press any one of the preset buttons (1 through 6) that has your desired characteristic in memory to recall the stored settings.

The adjusted contents of Parametric EQ/T.Correction/X-Over stored into the preset button will be demonstrated.

- 2 Press the preset button again during the demonstration to recall the stored settings.

About Time Correction

The distance between the listener and the speakers in a car vary widely due to the complex speaker placement. This difference in the distances from the speakers to the listener creates a shift in the sounds image and frequency characteristics. This is caused by the time delay between the sound reaching the listener's right versus the left ear.

To correct this, this unit is able to delay the audio signal to the speakers closest to the listener. This effectively creates a perception of increased distance for those speakers. The listener can be placed at an equal distance between the left and right speakers for optimum staging. The adjustment will be made for each speaker in 3.4cm steps.

Listening Position example as follows:

Example 1: Front Left Seat

Adjust the time correction level of the front left speaker to a high value and the rear right to zero or a low value.

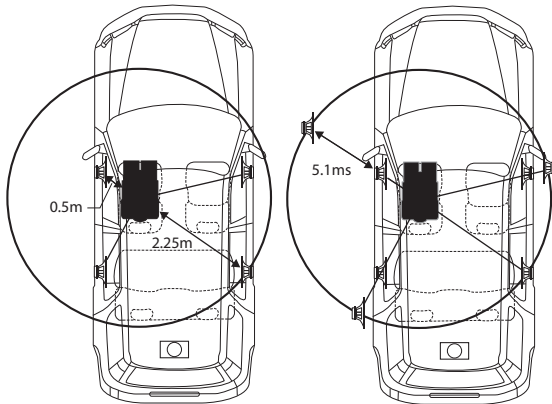

The sound is not balanced because the distance between the listening position and the various speakers is different.

The difference in distance between the front left speaker and the rear right speaker is 1.75 m (68-7/8").

Here we calculate the time correction value for the front left speaker in the diagram on the above.

Conditions:

Farthest Speaker - listening position : 2.25 m (88-9/16")

Front left speaker - listening position : 0.5 m (19-11/16")

Calculation: $L = 2.25 \text{ m} - 0.5 \text{ m} = 1.75 \text{ m} (68-7/8")$

Time correction = $1.75 \div 343 \times 1000 = 5.1 \text{ (ms)}$

* Speed of sound: 343 m/s (765 mph) at 20°C

In other words, giving the front left speaker a time correction value of 5.1 ms makes it seem as if its distance from the listener is the same as the distance to the farthest speaker.

Time correction eliminates the differences in the time required for the sound to reach the listening position.

The time of the front left speaker is corrected by 5.1 ms so that its sound reaches the listening position at the same time as the sound of other speakers.

Example 2: All Seats

Adjust the time correction level of each speaker to almost the same level.

- 1 Sit in the listening position (driver's seat, etc.) and measure the distance (in meters) between your head and the various speakers.

- 2 Calculate the difference between the distance correction value to the farthest speaker and the other speakers.

$L = (\text{distance to farthest speaker}) - (\text{distance to other speakers})$

These values are the time correction values for the different speakers. Setting these values to make each sound reach the listening position at the same time as the sound of other speakers.

Time Correction Value List

Delay Number	Time Difference (ms)	Distance (cm)	Distance (inch)
0	0.0	0.0	0.0
1	0.1	3.4	1.3
2	0.2	6.8	2.7
3	0.3	10.2	4.0
4	0.4	13.6	5.4
5	0.5	17.0	6.7
6	0.6	20.4	8.0
7	0.7	23.8	9.4
8	0.8	27.2	10.7
9	0.9	30.6	12.1
10	1.0	34.0	13.4
11	1.1	37.4	14.7
12	1.2	40.8	16.1
13	1.3	44.2	17.4
14	1.4	47.6	18.8
15	1.5	51.0	20.1
16	1.6	54.4	21.4
17	1.7	57.8	22.8
18	1.8	61.2	24.1
19	1.9	64.6	25.5
20	2.0	68.0	26.8
21	2.1	71.4	28.1
22	2.2	74.8	29.5
23	2.3	78.2	30.8
24	2.4	81.6	32.2

Delay Number	Time Difference (ms)	Distance (cm)	Distance (inch)
25	2.5	85.0	33.5
26	2.6	88.4	34.8
27	2.7	91.8	36.2
28	2.8	95.2	37.5
29	2.9	98.6	38.9
30	3.0	102.0	40.2
31	3.1	105.4	41.5
32	3.2	108.8	42.9
33	3.3	112.2	44.2
34	3.4	115.6	45.6
35	3.5	119.0	46.9
36	3.6	122.4	48.2
37	3.7	125.8	49.6
38	3.8	129.2	50.9
39	3.9	132.6	52.3
40	4.0	136.0	53.6
41	4.1	139.4	54.9
42	4.2	142.8	56.3
43	4.3	146.2	57.6
44	4.4	149.6	59.0
45	4.5	153.0	60.3
46	4.6	156.4	61.6
47	4.7	159.8	63.0
48	4.8	163.2	64.3
49	4.9	166.6	65.7
50	5.0	170.0	67.0
51	5.1	173.4	68.3
52	5.2	176.8	69.7
53	5.3	180.2	71.0
54	5.4	183.6	72.4
55	5.5	187.0	73.7
56	5.6	190.4	75.0
57	5.7	193.8	76.4
58	5.8	197.2	77.7
59	5.9	200.6	79.1
60	6.0	204.0	80.4
61	6.1	207.4	81.7
62	6.2	210.8	83.1
63	6.3	214.2	84.4
64	6.4	217.6	85.8
65	6.5	221.0	87.1
66	6.6	224.4	88.4
67	6.7	227.8	89.8
68	6.8	231.2	91.1
69	6.9	234.6	92.5
70	7.0	238.0	93.8
71	7.1	241.4	95.1
72	7.2	244.8	96.5
73	7.3	248.2	97.8
74	7.4	251.6	99.2

Delay Number	Time Difference (ms)	Distance (cm)	Distance (inch)
75	7.5	255.0	100.5
76	7.6	258.4	101.8
77	7.7	261.8	103.2
78	7.8	265.2	104.5
79	7.9	268.6	105.9
80	8.0	272.0	107.2
81	8.1	275.4	108.5
82	8.2	278.8	109.9
83	8.3	282.2	111.2
84	8.4	285.6	112.6
85	8.5	289.0	113.9
86	8.6	292.4	115.2
87	8.7	295.8	116.6
88	8.8	299.2	117.9
89	8.9	302.6	119.3
90	9.0	306.0	120.6
91	9.1	309.4	121.9
92	9.2	312.8	123.3
93	9.3	316.2	124.6
94	9.4	319.6	126.0
95	9.5	323.0	127.3
96	9.6	326.4	128.6
97	9.7	329.8	130.0
98	9.8	333.2	131.3
99	9.9	336.6	132.7

About the Crossover

Crossover (X-Over):

This unit is equipped with an active crossover. The crossover limits the frequencies delivered to the outputs. Each channel is controlled independently. Thus, each speaker pair can be driven by the frequencies for which they have been optimally designed. The crossover adjusts the HPF (high pass filter) or LPF (low pass filter) of each band, and also the slope (how fast the filter rolls off the highs or lows).

Adjustments should be made according to the reproduction characteristics of the speakers. Depending on the speakers, a passive network may not be necessary. If you are unsure about this point, consult your authorized Alpine dealer.

	Cut-off frequency (1/3 octave steps)		Slope		Level
	HPF	LPF	HPF	LPF	
Low range speaker	----	20 Hz - 200 Hz	----	Flat, 6, 12, 18, 24 dB/oct.	0 to -12 dB
Rear high range speaker	20 Hz - 200 Hz	----	Flat, 6, 12, 18, 24 dB/oct.	----	0 to -12 dB
Front high range speaker	20 Hz - 200 Hz	----	Flat, 6, 12, 18, 24 dB/oct.	----	0 to -12 dB

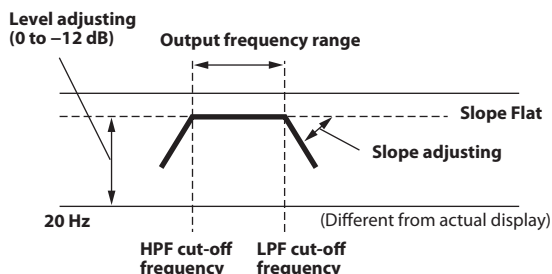
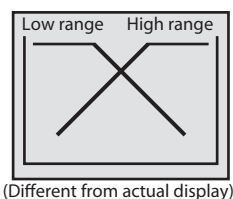

Notes

- *HPF (high pass filter): Cuts the lower frequencies and allows the higher frequencies to pass.*
- *LPF (low pass filter): Cuts the higher frequencies and allows the lower frequencies to pass.*
- *Slope: The level change (in dB) for a frequency change of one octave.*
- *The higher the slope value, the steeper the slope becomes.*
- *Adjust the slope to Flat to bypass the HP or LP filters.*
- *Do not use a tweeter without the HPF on or set to a low frequency, as it may cause damage to the speaker due to the low frequency content.*
- *You cannot adjust the crossover frequency higher than the HPF or lower than the LPF.*
- *Adjustment should be made according to the recommended crossover frequency of the connected speakers. Determine the recommended crossover frequency of the speakers. Adjusting to a frequency range outside that recommended may cause damage to the speakers. For the recommended crossover frequencies of Alpine speakers, refer to the respective Owner's Manual.*
We are not responsible for damage or malfunction of speakers caused by using the crossover outside the recommended value.

Other Functions

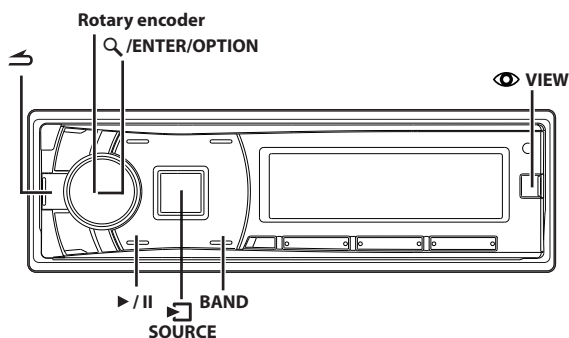

Displaying the Text

Text information, such as the disc name and the track name, will be displayed if playing a CD text compatible disc. It is also possible to display the folder name, the file name and the tag, etc. while playing MP3/WMA/AAC files.

Press **VIEW**.

The display will change every time the button is pressed.

Note

- *When the Text Scroll is set to Manual (refer to "Scroll Setting (Text Scroll)" on page 27), press and hold **VIEW** for at least 2 seconds, the current text will be scrolled one time (except Radio mode).*

The display in HD Radio mode:

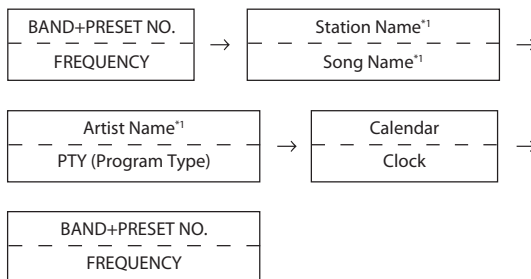

The display in CD mode:

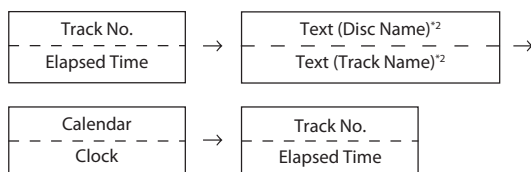

The display in MP3/WMA/AAC mode:

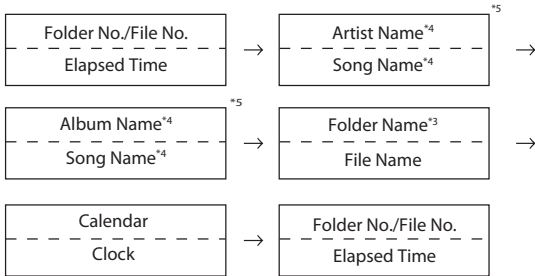

The display in BLUETOOTH Audio mode:

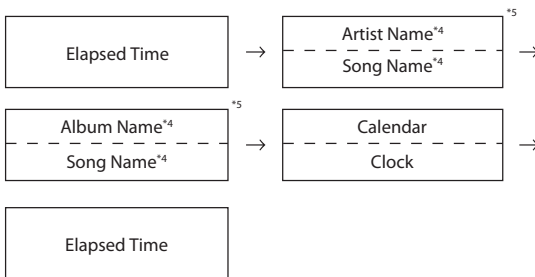

- *1 When an HD Radio signal is received, text information such as Radio Station, Artist, etc., is displayed.
If there is no text information, nothing will be displayed.
- *2 Displayed during playback of a disc with CD Text.
If there is no text information, nothing will be displayed.
- *3 The root folder of disc/Flash Memory is displayed as “\ROOT”.
If there is no text information, nothing will be displayed.
- *4 If an MP3/WMA/AAC file contains ID3 tag/WMA tag information, the ID3 tag/WMA tag information is displayed (e.g., song name, artist name, and album name). All other tag data is ignored.
If there is no text information, nothing will be displayed.
- *5 When the Text Scroll (refer to “Scroll Setting (Text Scroll)” on page 27) is set to “Auto”, the display cannot be switched by pressing VIEW. The display contents switch alternately.

About the indication display

When displaying Text, the following indicators are lit according to the mode.

Indicator/ Mode	HD Radio Mode	CD Mode	MP3/WMA/AAC Mode	iPod/iPhone/ BLUETOOTH Audio Mode
	—	—	Folder Name being displayed	—
	Artist Name being displayed	—	Artist Name being displayed	Artist Name being displayed
	—	—	Album Name being displayed	Album Name being displayed
	—	—	File Name being displayed	—
	—	Text (Disc Name) being displayed	—	—
	Song Name being displayed	Text (Track Name) being displayed	Song Name being displayed	Song Name being displayed
	Station Name being displayed	—	—	—
	PTY (Program Type) being displayed	—	—	—

About “Text”

Text compatible CDs contain text information such as the disc name and track name. Such text information is referred to as “text”.

Notes

- Some characters may not be displayed correctly with this device, depending on the character type.
- If there is no TEXT information, the display is blank.
- The text or tag information may not be correctly displayed, depending on the contents.

Option Menu Setting

You can quickly adjust the setting items relevant to the current SOURCE by using Option Menu.

- 1 Press and hold /ENTER/OPTION for at least 2 seconds to activate the Option menu of the current source.

Note

- The option menu varies depending on the source.

- 2 Turn the Rotary encoder to select the desired setting item, and then press /ENTER.

3 Turn the Rotary encoder to change the setting, and then press **Q/ENTER**.

After the setting, the display will return to the current source automatically.

Setting item:

HD Radio mode:

Tuner Setup^{*1} ↔ VOL LV ADJ^{*2} ↔ MX Setup^{*3} ↔ Tuner Setup

SiriusXM mode:

Alert Memory^{*4} ↔ SiriusXM Setup^{*5} ↔ VOL LV ADJ^{*2} ↔ MX Setup^{*3} ↔ Alert Memory

DISC mode:

CD Setup^{*6} ↔ VOL LV ADJ^{*2} ↔ MX Setup^{*3} ↔ CD Setup

USB mode:

USB Setup^{*7} ↔ VOL LV ADJ^{*2} ↔ MX Setup^{*3} ↔ USB Setup

iPod mode:

APP Direct^{*8} ↔ iPod Setup^{*9} ↔ VOL LV ADJ^{*2} ↔ MX Setup^{*3} ↔ APP Direct

AUX mode:

AUX Setup^{*10} ↔ VOL LV ADJ^{*2} ↔ MX Setup^{*3} ↔ AUX Setup

Pandora mode:

VOL LV ADJ^{*2} ↔ MX Setup^{*3} ↔ VOL LV ADJ

BT Audio mode:

BT Setup^{*11} ↔ VOL LV ADJ^{*2} ↔ MX Setup^{*3} ↔ BT Setup

Phone mode (Non-calling mode):

Phone Setup^{*12} ↔ VOL LV ADJ^{*13} ↔ Phone Setup

Phone mode (Calling mode):

MIC Gain^{*14} ↔ Call Sound^{*14} ↔ Speak Switch^{*15} ↔ Voice Mute^{*16} ↔ Call Wait^{*17} ↔ END Call^{*18} ↔ VOL LV ADJ^{*13} ↔ MIC Gain

^{*1} The setting items are the same as Tuner setting in SETUP mode. For details, refer to "SETUP" on page 25.

^{*2} You can individually emphasize or weaken the volume level of the current source to create your own tonal preference. The setting values in Option mode and in SETUP mode are linkage. Refer to "Setting the Source Volume Level" on page 17.

^{*3} Refer to "Setting the Media Xpander mode (MX Setup)" on page 18.

^{*4} Refer to "Storing the desired Artist and Song Alerts" on page 44.

^{*5} Alert Setup, Games Alert Setup, Parental Lock and Signal Indicator can be selected in this mode. For details about these settings, refer to "SiriusXM Setting" on page 43.

^{*6} Play Mode can be selected in this mode. For details, refer to "Playing MP3/WMA/AAC Data (Play Mode)" on page 26.

^{*7} USB Skip can be selected in this mode. For details, refer to "Setting the USB Skip function" on page 28.

^{*8} Refer to "Setting the iPod Control" on page 37.

^{*9} iPod List Setup can be selected in this mode. For details, refer to "iPod/iPhone Search Mode Setting" on page 28.

^{*10} AUX Name can be selected in this mode. For details, refer to "Setting the AUX NAME mode" on page 26.

^{*11} FW VERSION can be selected in this mode. You can see the current firmware version about BLUETOOTH by using this setting.

^{*12} Call Sound, Caller ID, PB Update, PB Order, Auto Answer, Service Name, Speaker Select and FW Version can be selected in this mode. For details about these settings, refer to "BLUETOOTH SETUP" on page 30.

^{*13} The Hands free phone talk level, ring tone level and microphone gain level can be adjusted by using this setting. Changing the settings in the Option mode will also affect the same settings in the SETUP menu. Refer to "Adjusting the volume (VOL LV ADJ)" on page 31.

^{*14} Refer to "Setting the BLUETOOTH sound quality" on page 31.

^{*15} While calling, the call sound can be switched between the unit and Smartphone by using this setting.

This operation can also be done by pressing **BAND**. Refer to "Call Switching Operation" on page 34.

^{*16} While calling, and the Voice Mute is activated, the microphone input will mute instantly and "VOICE MUTE" will blink. This operation can also be done by pressing **▶/II**. Refer to "Muting the microphone input quickly (Voice Mute)" on page 34.

^{*17} If there is a waiting call, select this item to display the caller's Name and waiting number (1 or 2). Press **VIEW** and the display will switch.

^{*18} Select this item to hang up the call.

Notes

- Press **←** to return to the previous mode.
- If no operation is performed for 60 seconds, the unit will return to normal mode automatically.

Applying TuneIt

This unit's sound tuning is programmable from a connected Smartphone. It is also possible to download specific parameters for certain vehicles from Alpine's TuneIt database stored in the Cloud. Using the TuneIt App, customized parameters can also be uploaded for others to share and rate.

Through this unit, it is also possible to receive and respond to information from Alpine's Social Network Service (SNS) available through the connected Smartphone.

The installed TuneIt App should be launched on the Smartphone before connection to the head unit. TuneIt, is downloadable from Apple's App Store; the Android user can download it from Google Play. For details, consult your Alpine dealer.

Before these operations, set Alpine APP to USB or BT depending on the connected Smartphone. For details, refer to "Setting the communication mode with a Smartphone (Alpine APP)" on page 28.

Notes

- The application program and the related specifications and data may be deleted or terminated without notice.
- Some functions of TuneIt may not be available when the Smartphone is not in service area or receives no signal.

Adjusting the sound via Smartphone

After the above procedure, you can adjust the unit's sound function on the Smartphone.

- 1 Make sure the unit is powered on.
- 2 Launch the TuneIt App on Smartphone. Adjust the unit's sound accordingly on the Smartphone.

During sound setting, **◀/SOURCE** key may blinks.

Notes

- Volume and sound parameter preset function cannot be adjusted via Smartphone.
- The setting cannot be done on both the Smartphone and this unit at the same time. While the sound function of this unit is set via the Smartphone, sound function settings on CDE-HD149BT will be displayed as "APP Connect".
- When the unit is powered off or during a call, sound setting cannot be done via the Smartphone.
- This function may not be available depending on the paired Smartphone.
- Please obey all local traffic laws while using this function.

Facebook Notification Function

Some functions may be available in a future version of TuneIt.

Note

- Depending on the paired Smartphone, the follows functions may not available even though the TuneIt version is updated.

Receiving Notification (Ready on future update)

When the Smartphone connected to this unit receives notification from Facebook, it will BEEP and the SOURCE key blinks (depending on the TuneIt settings on the phone). At the same time, the user's name is shown in the display (20 characters maximum).

- While receiving Notification from Facebook, press **↔/SOURCE** button.
Notification Menu screen is displayed.
- Turn the **Rotary encoder** to select the desired mode, and then press **🔍/ENTER**.

Like^{*1} ↔ Replay ↔ Next ↔ Previous ↔ TTS Volume^{*2} ↔ Like

^{*1} Not displayed only when the received Notification is Message type.

^{*2} It can also be set in SETUP section. For details, refer to "Setting the TTS (Text To Speech) volume" on page 28.

- Like:** The Smartphone feedbacks to Facebook with "Like", and meanwhile, the received Wall Posts or Comments is played back by TTS (Text To Speech).
- Replay:** To play back Notification by TTS (Text To Speech) again.
- Next:** To select the next Notification.
- Previous:** To select the previous Notification.
- TTS Volume:** To adjust the playback volume of TTS (Text To Speech).

Notes

- Press **↩** to return to the previous mode.
- A new received Notification prompt will last for 30 seconds. If there is no operation within 30 seconds, the unit will return to normal mode.
- When this unit is powered off or during a call, Notification of Smartphone will not be prompted by this unit.

Displaying Notification List (Ready on future update)

You can view the received Notification from Facebook in the connected Smartphone via this unit.

- Press and hold **↔/SOURCE** for at least 2 seconds.
The received Notification will be displayed according to when it was posted.
- Turn the **Rotary encoder** to select the desired Notification, and then press **🔍/ENTER**.
- Then go to step 2 of "Receiving Notification".

Notes

- When there is no Notification, "No Notification" will be displayed.
- The displayable amount of the Notification list depends on the connected Smartphone.

SETUP

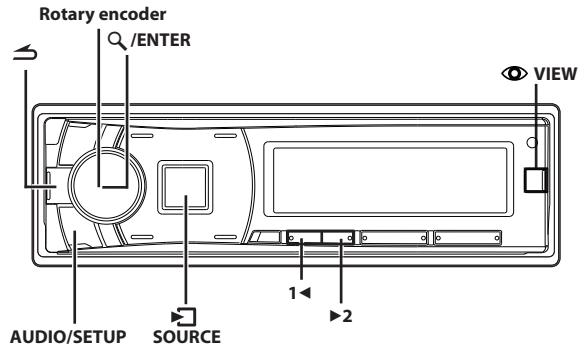

Setting

You can flexibly customize the unit to suit your own preferences and usage. From the SETUP menu, General Setting, Display Setting, etc. can be modified.

Use steps 1 to 5 to select one of the SETUP modes to modify. See the applicable section below for details about the selected SETUP item.

- Press and hold **AUDIO/SETUP** for at least 2 seconds to activate the SETUP mode.
- Turn the **Rotary encoder** to select the desired item, and then press **🔍/ENTER**.
Audio^{*1} ↔ General ↔ Display ↔ Tuner ↔ SiriusXM^{*2} ↔ iPod&USB ↔ Application ↔ Bluetooth^{*3} ↔ Audio
- Turn the **Rotary encoder** to select a setting item, and then press **🔍/ENTER**.

General:

Clock Mode ↔ Clock Adjust^{*4} ↔ Calendar ↔ AUX IN ↔ AUX Name^{*5} ↔ Play Mode ↔ Beep ↔ Demo ↔ Clock Mode

Display:

Illumination ↔ Dimmer ↔ Dimmer Level ↔ Scroll Type ↔ Text Scroll ↔ Opening MSG ↔ Illumination

Tuner:

Multi Cast Seek ↔ Seek Type ↔ Listen Mode ↔ Live Mode ↔ FM Tuner Setup ↔ Multi Cast Seek

iPod&USB:

USB Skip ↔ iPod List Setup ↔ USB Skip

Application:

Alpine APP ↔ TTS Volume ↔ Alpine APP

^{*1} Refer to "Audio Setup" on page 17.

^{*2} Refer to "SiriusXM Setting" on page 43.

^{*3} Refer to "BLUETOOTH SETUP" on page 30.

^{*4} Refer to "Setting the Time and Calendar" on page 10.

^{*5} Displayed only when AUX IN is ON.

- Turn the **Rotary encoder** to change the setting, and then press **🔍/ENTER**.
- Press and hold **AUDIO/SETUP** for at least 2 seconds to return to normal mode.

Notes

- Pressing  returns to the previous SETUP mode.
- If no operation is performed for 60 seconds, SETUP is canceled.

General Setting

General is selected on the setup main menu in step 2.

Setting the Clock Display (Clock Mode)

You can select the clock display type, 12-hour or 24-hour, depending on your preference.

■ Setting item: Clock Mode

Setting contents:

00:00 (24-hour) / AM (Before noon) 12:00 (12-hour) (Initial setting)

Setting of Calendar Display Pattern Switching (Calendar)

You can switch the calendar display pattern to be shown when the time is displayed.

■ Setting item: Calendar

Setting contents:

mm/dd/yyyy (Initial setting) / dd/mm/yyyy / yyyy/mm/dd

yyyy:

Shows the year

mm:

Shows the month

dd:

Shows the day

ex. dd/mm/yyyy → 01/01/2013

Setting the AUX SETUP mode

You can input the audio of an external device, (such as a Portable audio player) to the AUX connector of this unit.

■ Setting item: AUX IN

Setting contents:

OFF / ON (Initial setting)

OFF:

When set to OFF, AUX source cannot be selected.

ON:

Set to ON when a portable device is connected. If  /SOURCE is pressed and AUX is selected, the sound of the portable device is input to the unit.

Setting the AUX NAME mode

You can change the AUX NAME display in the SETUP mode.

■ Setting item: AUX Name

Setting contents:

Auxiliary (Initial setting) / TV / DVD / Portable / Game

Playing MP3/WMA/AAC Data (Play Mode)

This unit can play back CDs containing both CD and MP3/WMA/AAC data (created in Enhanced CD (CD Extra) format). However, in some situations, playback of an enhanced CD may be difficult. In this case, you can select playback of a single session only, containing the CD data. When a disc contains both CD and MP3/WMA/AAC data, playback starts from the CD data portion of the disc.

■ Setting item: Play Mode

Setting contents:

CD-DA / CDDA&MP3/WMA (Initial setting)

CD-DA:

Only the CD data in Session 1 can be played back.

CDDA&MP3/WMA:

CD data, MP3/WMA/AAC files in mixed mode, and multi-session discs can be played back.

Note

- Perform this setting before inserting a disc. If a disc has already been inserted, remove it first.

Sound (Beep) Guide Function

This function will give audible feedback with varying tones depending upon the button pressed.

■ Setting item: Beep

Setting contents:

OFF / Level 1~7

Note

- The initial setting is Level 4.

Demonstration

This unit has a demonstration feature for the display.

■ Setting item: Demo

Setting contents:

OFF (Initial setting) / ON

Note

- To quit Demo mode, set to Demo OFF.

Display Setting

Display is selected on the setup main menu in step 2.

Changing Lighting Color

You can change the lighting color of the unit's buttons.

■ Setting item: Illumination

Setting contents:

TYPE1 (Initial setting) / TYPE2 / TYPE3 / TYPE4

TYPE1:

The color of all buttons is blue.

TYPE2:

The color of all buttons is green.

TYPE3:

The color of all buttons is amber.

TYPE4:

The color of all buttons is red.

Dimmer Control

Set the Dimmer control to Auto to decrease the illumination brightness of the unit with the head lights of the vehicle ON. This mode is useful if you feel the unit's backlighting is too bright at night.

■ Setting item: Dimmer

Setting contents:

Manual / Auto (Initial setting)

Dimmer Level Setting

In the Dimmer Level setting, three levels are available, the highest level (Level3) being the dimmest when the car headlights are on.

■ Setting item: Dimmer Level

Setting contents:

Level1 (Initial setting) / Level2 / Level3

Scroll Type Setting

Choose from two scrolling methods.
Select the type you prefer.

■ Setting item: Scroll Type

Setting contents:

TYPE 1 (Initial setting) / TYPE 2

TYPE 1:

The characters scroll from right to left, one character at a time, until the entire title has scrolled.

TYPE 2:

Words are built up from left to right, a single character at a time. When the display is full, it is cleared and the subsequent words are displayed the same way until all words of the title have been shown.

Scroll Setting (Text Scroll)

This CD player can scroll the disc and track names recorded on CD-TEXT discs, as well as text information of MP3/WMA/AAC files, folder names, tags, HD Radio broadcasts and SiriusXM.

■ Setting item: Text Scroll

Setting contents:

Manual (Initial setting) / Auto

Manual:

The above information is scrolled only when a disc is loaded, a channel or track is changed, etc.

Auto:

CD text information, folder and file names, HD Radio and SiriusXM text are scrolled continuously. In addition, all tag information is automatically rotated in the display continuously, without pressing the **VIEW** button. (Except SiriusXM)

Note

- In parts of the display, scrolling may not occur, or scroll content may differ.

Opening Message ON/OFF Setting

This unit includes a special message feature with various patterns, which when enabled displays opening messages for certain occasions.

For example, when you turn this unit on December 25th (according to the unit's date setting), a Christmas greeting is displayed if the Opening Message is set to ON.

■ Setting item: Opening MSG

Setting contents:

OFF (Initial setting) / ON

Tuner Setting

Tuner is selected on the setup main menu in step 2.

Setting the Multicast Seek

Multicast Seek can be set to ON/OFF.

■ Setting item: Multi Cast Seek

Setting contents:

OFF / ON (Initial setting)

OFF:

SEEK is available only for the Main Program Service. Multicast stations are ignored.

ON:

SEEK finds both the Main Program Service and Sub-program Service of Multicast stations.

Setting the Digital Seek

Digital Seek can be set to ON/OFF.

■ Setting item: Seek Type

Setting contents:

Hybrid (Initial setting) / Digital

Hybrid:

SEEK UP/DOWN is available for digital and analog radio stations. However, the strong signals have priority during SEEK.

Digital:

SEEK UP/DOWN is available only for the digital radio station. Any analog only stations (or very weak digital) are skipped.

Switching the listening mode

The unit provides you 4 reception methods, among which you can select an optimized method to receive the Digital signal or Analog signal according to your own preference and the signal strength.

■ Setting item: Listen Mode

Setting contents:

Hybrid / Digital / Digital MC (Initial setting) / Analog

Hybrid:

Receive both digital and analog radio stations. If the digital signal is weak, this unit will switch to receive the analog radio signal automatically.

Digital:

Keep receiving the digital radio signal, even when the digital signal is weak.

Digital MC:

Keep receiving the digital radio signal while listen to a Sub-program Service of a Multicast station.

Analog:

Only receive the analog radio signal, even when the digital signal is strong.

Setting the Live mode (Live Mode)

While receiving a live broadcast, you can select an optimized receiving method according to your own preference and the signal strength.

■ Setting item: Live Mode

Setting contents:

Analog (Initial setting) / Digital / Listen Mode

Analog:

While receiving a live broadcast, this unit will only receive the analog radio signal even when the digital signal can be received.

Digital:

While receiving a live broadcast, this unit will keep receiving the digital radio signal even when the digital signal is weak.

Listen Mode:

While receiving a live broadcast, the setting value is the same as that in Listen Mode, refer to "Switching the listening mode" on page 27.

Setting the TUNER (FM) tone quality

This unit can set your preferred tone quality for FM radio source.

■ Setting item: FM Tuner Setup

Setting contents:

Hi-Fi / Normal (Initial setting) / Stable

Hi-Fi:

High-quality setting

Normal:

Standard setting

Stable:

Control noise

Note

- *Noise may be more noticeable when Hi-Fi is set, depending on the reception status. In this case, the Normal setting is recommended.*

iPod&USB Setting

iPod&USB is selected on the setup main menu in step 2.

Setting the USB Skip function

During searching, you can skip over designated folders/files by pressing and holding **1** ◀/▶ **2** for at least 2 seconds. For example, if you select 10File in the searching mode, by pressing and holding **1** ◀ you can skip backward 10 folders/files from the current folder/file; by pressing and holding ▶ **2** you can skip forward 10 folders/files from the current folder/file. If the folders/files searched are less than the assigned skipped-over ones, pressing and holding **1** ◀/▶ **2** will skip to the first or last folder/file.

■ Setting item: USB Skip

Setting contents:

10File (Initial setting) / 20File / 50File / 100File

iPod/iPhone Search Mode Setting

The unit allows you to search for the iPod/iPhone using nine different search modes.

■ Setting item: iPod List Setup

■ **Further setting items:** Playlists / Artists / Albums / Audiobooks / Podcasts / Genres / Composers / Songs / Genius Mixes

Setting contents:

OFF / ON

Notes

- *When the search mode is in Playlists/Artists/Albums/Podcasts/Genres/Songs/Genius Mixes, the initial setting is On, and when the search mode is in Audiobooks/Composers, the initial setting is Off.*
- *For search mode details, refer to "Searching for a desired song" on page 35.*

Application Setting (APP)

Application is selected on the setup main menu in step 2.

Setting the communication mode with a Smartphone (Alpine APP)

Set Alpine APP to USB when an iPhone is connected, or set to BT when an Android Smartphone is paired.

■ Setting item: Alpine APP

Setting contents:

OFF / USB (Initial setting) / BT

OFF:

No Smartphone is connected.

USB:

When an iPhone is connected to CDE-HD149BT's USB port, you can enjoy Pandora program the unit's sound tuning parameters, or communicate with SNS.

BT:

Set this when an Android Smartphone is paired with this unit via BLUETOOTH technology. At this time, you can enjoy Pandora, program the unit's sound tuning parameters, or communicate with SNS.

Notes

- *After the above setting, turn the ignition key off (ACC OFF) and on again (ACC ON).*
- *For this function to work properly, specific applications must be installed on your Smartphone before connection. Consult your Alpine dealer or the Alpine web site for details.*
- *Only the iPhone and certain Android Smartphones support this function.*

Setting the TTS (Text To Speech) volume

This function allows for readout of comments, etc., on a Smartphone, and outputs sound from the speaker of the unit.

■ Setting item: TTS Volume

Setting contents:

0~35

Note

- *The initial volume level is 12.*

BT Hands Free Calling

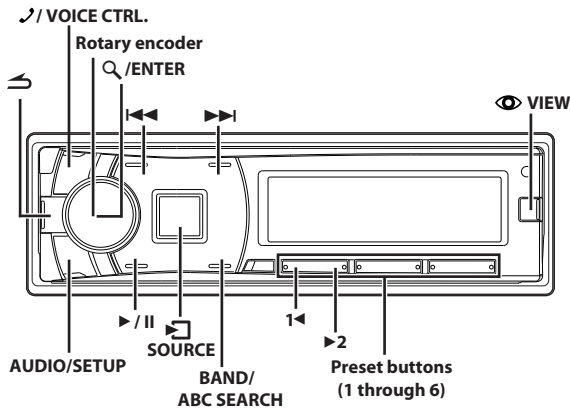

Setup Before Using

About BLUETOOTH

BLUETOOTH is a wireless technology allowing communication between a mobile device or personal computer over short distances. This enables a hands-free call or data transmission between BLUETOOTH compatible devices. BLUETOOTH transmission is available in the unlicensed 2.4 GHz spectrum if the distance between devices is within 10 meters. For details, refer to the BLUETOOTH Home page (<http://www.bluetooth.com>).

Notes

- Depending on the BLUETOOTH version, a BLUETOOTH compatible device may not be able to communicate with this unit.
- Proper function of this unit with all BLUETOOTH compatible devices is not guaranteed. For handling of the BT compatible device, consult your ALPINE dealer or ALPINE website.
- Depending on the surroundings, BLUETOOTH wireless connection may be unstable.
- When you place a call, or perform setup operations, be sure to stop your car in a safe place.
- Depending on the connected BLUETOOTH compatible device(s), the function may differ. Also refer to the Owner's Manual of the connected device(s).
- When you search for this unit using the BLUETOOTH compatible phone, the unit name is displayed as "Alpine CD Receiver".

Before Using BLUETOOTH Function

Before using the BLUETOOTH function, the following settings need to be made.

Set "Bluetooth IN" to ON when you want to use Hands-Free phone or Bluetooth Audio function. Refer to "Setting the BLUETOOTH Connection (Bluetooth IN)" on page 30.

Note

- Before using BLUETOOTH function, it must be paired with this unit. Refer to "How to connect to a BLUETOOTH compatible device (Pairing)" on page 29.

How to connect to a BLUETOOTH compatible device (Pairing)

For details on the control from a BLUETOOTH compatible device, refer to the Owner's Manual of the BLUETOOTH compatible device.

Pairing a BLUETOOTH compatible device with SSP (Secure Simple Pairing)

- 1 Using your BLUETOOTH compatible device, select the "Alpine CD Receiver" for pairing.
- 2 Turn the Rotary encoder to change the head unit display from "Pairing NO" to "Pairing YES", and then press Q/ENTER.
If "Pairing NO" is selected, the connection will be canceled.
- 3 If the pairing was successful, "Connected" is displayed for a few seconds. The head unit then returns to its previous state.

Pairing a BLUETOOTH compatible device without SSP (Secure Simple Pairing)

- 1 Using your BLUETOOTH compatible device, select the "Alpine CD Receiver" for pairing.
- 2 Input the passcode ("0000") in a BLUETOOTH compatible device.
Note
 - The passcode is fixed as "0000".
- 3 If the pairing was successful, "Connected" is displayed for a few seconds. The head unit then returns to its previous state.

Notes

- If the connection is unsuccessful, "Failed" is displayed.
- After a successful pairing, the two devices should reconnect automatically whenever the vehicle's ignition is turned ON. If the auto connection fails, try to reconnect manually.
- Set "Visible Mode" to ON to enable this unit to be recognized by a BLUETOOTH compatible device, refer to "Setting the Visible Mode" on page 30.
- You can also manually pair the BLUETOOTH devices from this unit. For details, refer to "Pairing a BLUETOOTH Device from the unit" on page 30.

BLUETOOTH SETUP

The following steps 1 to 5 are common to the various BLUETOOTH functions. For details, refer to each individual function.

Note

- Set "Bluetooth IN" to ON, and then perform BLUETOOTH SETUP operation. Refer to "Setting the BLUETOOTH Connection (Bluetooth IN)" on page 30.

- Press and hold **AUDIO/SETUP** for at least 2 seconds to activate the SETUP mode.
- Turn the **Rotary encoder** to select "Bluetooth", and then press **Q/ENTER**.
The BLUETOOTH setup mode is activated.

- Turn the **Rotary encoder** to select the desired items and then press **Q/ENTER**.

BLUETOOTH:

Bluetooth IN^{*1} ↔ Paired Device^{*2} ↔ Visible Mode^{*1/*2} ↔ Search Device^{*1/*2} ↔ Call Sound^{*2} ↔ Caller ID^{*2} ↔ PB Update^{*1/*2} ↔ PB Order^{*2} ↔ Auto Answer^{*2} ↔ Service Name^{*2} ↔ Speaker Select^{*2} ↔ FW Version^{*2} ↔ FW Update^{*1/*2} ↔ Bluetooth IN

*1 The items are not displayed during a phone call.

*2 The items are not displayed if "Bluetooth IN" is set to OFF. Refer to "Setting the BLUETOOTH Connection (Bluetooth IN)" on page 30.

- Turn the **Rotary encoder** to change the settings.
- Press and hold **AUDIO/SETUP** for at least 2 seconds.
The SETUP mode is canceled.

Notes

- Press **↶** to return to the previous mode.
- If no operation is performed for 60 seconds, the unit will return to normal mode automatically.

Setting the BLUETOOTH Connection (Bluetooth IN)

With BLUETOOTH technology, you can place a hands-free call by a BLUETOOTH-equipped Smartphone. Audio information of a BLUETOOTH compatible Smartphone, a portable audio player, etc., is controllable/playable wirelessly from this unit.

Setting item: Bluetooth IN

Setting contents:

OFF / ON (Initial setting)

OFF:

Hands-Free Phone function and Bluetooth Audio function are not used.

ON:

Select when you want to pair your BLUETOOTH compatible phone with this unit or use Bluetooth Audio function.

Note

- When Bluetooth IN is set to OFF, the indicators related to Hands-free phone (**BATT** battery quantity and **Y** signal strength) will not be displayed.

Setting the BLUETOOTH Device

Select one of 3 connected BLUETOOTH compatible devices that you previously registered.

Setting item: Paired Device

- Turn the **Rotary encoder** to select a BLUETOOTH compatible device you want to use (you want to change connection) and then press **Q/ENTER**.
- Turn the **Rotary encoder** to select "Connect" to connect the selected device.
The connected device is marked with "*". Select "Disconnect" to disconnect this device. Select "Clear" when you want to clear the device from the device list.

Notes

- If the connection is successfully changed, "Connected" is displayed for 2 seconds and the **B** indicator lights up, then the display returns to the SETUP screen.
- If a Smartphone is connected to this unit successfully, the **BATT** indicator lights up to show the battery charge of the connected Smartphone. The **BATT** indicator lights up when the battery charge is about 50%, the **BATT** indicator lights up when the battery charge is not enough, and it blinks as a low level warning. The **BATT** indicator goes out when the battery is drained. At this time, the BLUETOOTH function is unavailable due to the Smartphone powered off.
- Indicator **Y** (Signal Strength):
The indicator will display the current signal strength of your service provider. The **Y** indicator goes out when the Smartphone is not in service area or receives no signal.
- Depending on the connected Smartphone, the **BATT** (battery charge), and **Y** (signal strength) indicators may not be displayed.
- If all the 3 positions have been registered, you cannot register the 4th device. To register another device, you need to delete one of the devices from position 1 to 3 first.

Setting the Visible Mode

You can set whether this unit can be recognized or not from a BLUETOOTH compatible device. Normally set this to ON.

Setting item: Visible Mode

Setting contents:

OFF / ON (Initial setting)

OFF:

Disable recognition of this unit from the BLUETOOTH compatible device.

ON:

Enable recognition of this unit from the BLUETOOTH compatible device.

Pairing a BLUETOOTH Device from the unit

If your BLUETOOTH device is not immediately pairing, the head unit can perform a search. The search can find paired or unpaired devices.

Setting item: Search Device

- When Search Device is selected and "Searching" is displayed, the search gets started.

Note

- The "Searching" operation can be stopped by pressing **↶**.

2 Turn the **Rotary encoder** to select the name of the device to be connected from the Device Search list and then press **Q/ENTER**.

3 If this unit is successfully connected to a **BLUETOOTH compatible device**, "Connected" is displayed, and then the unit returns to normal mode.

Depending on the Smartphone, it may be necessary to input a passcode. In this case, "Passcode 0000" is displayed. Input the passcode "0000" in the BLUETOOTH compatible device to make the pairing. After the pairing is completed, the unit will automatically connect to the BLUETOOTH compatible device. If you input the wrong passcode or the communication fails, "Failed" is displayed.

Setting the BLUETOOTH sound quality

You can flexibly customize the sound of a call to fit your own preferences.

■ **Setting item:** Call Sound

■ **Further setting items:** VOL LV ADJ / Type Setup

Adjusting the volume (VOL LV ADJ)

You can emphasize or weaken the volume level of the Phone call, the ring tone and the microphone input to fit your own preferences.

Setting contents:

Phone Talk:
-5 dB ~ +5 dB

Ring Tone:
-5 dB ~ +5 dB

MIC Gain:
-5 dB ~ +5 dB

Sound Type setting (Type Setup)

Depending on your calling environment, choose one of the settings below which gives the best sound quality.

Setting contents:

TYPE1 (Initial setting) / TYPE2 / TYPE3 / TYPE4 / TYPE5

TYPE1:
Standard Mode (recommended)

TYPE2:
Enhances the noise reduction

TYPE3:
Enhances the echo-cancel

TYPE4:
Enhances both noise reduction and echo-cancel

TYPE5:
Weakens both noise reduction and echo-cancel

Note

- The functions below are designed to improve the sound quality of the outgoing call.
Noise reduction: This function can reduce the road noise, but excessive enhancement may affect the sound quality of the call.
Echo-cancel: This function can reduce the echo, but excessive enhancement may affect the sound quality of the call.

Setting the caller information display/text message indicator ON/OFF

You can choose whether to use these functions according to the following setting.

■ **Setting item:** Caller ID

Setting contents:

OFF / ON (Initial setting)

If you want to keep the ID information of the caller from others, set this item to OFF. Depending on the stored ID information, while you are dialing a number or a call is dialing in, only telephone number will be displayed or telephone name will be displayed as "NO Name"; During a call, "NO Name" will be displayed.

Setting the Phone Book Update

You can update the phone book automatically or manually.

■ **Setting item:** PB Update

■ **Further Setting contents:** Auto / Manual

Setting the Phone Book Auto Update ON/OFF (Auto)

When you select ON in this step, whenever the vehicle's ignition is turned ON or after the phone is reconnected with this unit, the phone book will be updated automatically.

Setting contents:

OFF / ON (Initial setting)

Note

- "Updating" will be displayed during the phone book update.

Setting the Phone Book Manual Update ON/OFF (Manual)

When you select YES in this step, the phone book will be updated immediately regardless if the Auto update function is on or off.

Setting contents:

NO (Initial setting) / YES

Note

- "Updating" will be displayed during the phone book update.

Changing the Phone book List Order

The phone book is listed alphabetically by the first letter of First or Last Name.

Listing by First Name is the default but Last Name can be selected.

■ **Setting item:** PB Order

Setting contents:

First Name (Initial setting) / Last Name

Note

- "Waiting" will be displayed while the Phone book order is switching. You can cancel the "Waiting" screen to perform other operations by pressing **↵** when the ordering is still in progress. The phone book is not accessible during this time. In addition, the ordering may affect the playback of Bluetooth Audio.

Setting the Received Calls automatically (Auto Answer)



When a call is received, you can set whether to receive it automatically or not.

Setting item: Auto Answer

Setting contents:

OFF (Initial setting) / ON

OFF:

When a call is received, it is not answered automatically. Press  or  /ENTER to receive the call.

ON:

When a call is received, it is answered automatically after about 5 seconds.

Note

- If the received call setting on the Smartphone is on, the call will be answered automatically even though this setting is set to OFF.

Displaying the phone service provider name

The service provider name of the connected BLUETOOTH compatible device will be displayed. If a BLUETOOTH compatible device is not connected, "ID Unsent" will be displayed.

Setting item: Service Name

Note

- Depending on the character type some phone service provider name cannot be displayed. "ID Unsent" will be displayed.

Selecting the output speaker

Choose the speaker in your vehicle from which you want to hear the call.

Setting item: Speaker Select

Setting contents:

ALL (Initial setting) / F-L / F-R / F-LR

ALL:

The sound be output from all of speakers in car.

F-L:

The sound only be output from the front left speaker.

F-R:

The sound only be output from the front right speaker.

F-LR:

The sound be output from the front left and front right speaker.

Displaying the firmware version

The current firmware version will be displayed.

Setting item: FW Version

Updating the firmware

Future BLUETOOTH firmware updates may become available for phone interoperability.

For detailed information and operation to update your BLUETOOTH firmware, please visit Alpine home page (<http://www.alpine-usa.com>).

Setting item: FW Update

Setting contents:

NO (Initial setting) / YES

Hands-Free Phone Control

About the Hands-Free Phone

Hands-free calls are possible when using a HSP (Head Set Profile) and HFP (Hands-Free Profile) compatible Smartphone with this unit.

Notes

- Avoid performing a hands-free call in heavy traffic or on narrow or winding streets.
- Close the windows while calling to reduce background noise.
- If both calling parties are using hands-free devices, or the call is made in a noisy location, difficulty hearing the other person's voice is normal.
- Depending on telephone line conditions or certain mobile devices used, voices may sound unnatural.
- When using a microphone, speak as directly as you can into the microphone to pick up the best sound quality.
- Certain Smartphone features are dependent on the capabilities and settings of your service provider's network. Additionally, certain features may not be activated by your service provider, and/or the provider's network settings may limit the feature's functionality. Always contact your service provider about feature availability and functionality.

All features, functionality, and other product specifications, as well as the information contained in the Owner's Manual are based upon the latest available information and are believed to be accurate at the time of printing.

Alpine reserves the right to change or modify any information or specifications without notice or obligation.

Answering a Call

Incoming calls are announced by the received call ring tone and a displayed message (Phone).

Press  or press  /ENTER.

The call starts.

Notes

- When "Auto Answer" is set to ON, you can receive a call automatically. Refer to "Setting the Received Calls automatically (Auto Answer)" on page 32.
- While calling, the source sound on the unit is muted. After calling, playback will resume.

Hanging up the Telephone

Press .

The call finishes.

Note

- You can also hang up the call by pressing .

Voice Control Operation

When a Smartphone equipped with voice recognition function is paired with this unit. The Smartphone can be controlled by Voice Control via this unit.

Press and hold VOICE CTRL. for at least 2 seconds to activate the Voice Recognition mode.

After the Voice Recognition mode is activated and "Speak" is displayed, you can make a phone call, play a song, etc., via this unit by inputting voice control commands.

* Please refer to your Smartphone manual for other voice control commands.

Notes

- You can perform this operation only when a Voice recognition compatible Smartphone is connected. If the Smartphone is not compatible with the Voice recognition, "No Support" is displayed for 2 seconds.
- The Voice recognition function performance depends on the recognition range of the Smartphone and mounting location of the microphone. Please pay attention when the microphone is mounted.
- Voice recognition operation depends on the function of the Smartphone. For details, refer to the Owner's Manual of the Smartphone.
- If a called person that you say is not found, "No Call" is displayed for 2 seconds.
- Please obey all local traffic laws while using this function.

Calling

Call History is recorded for the last dialed/received/missed calls (20 records for each). There are various ways of making calls based on the "Calling". The following steps 1 to 5 are common to the various ways of making these calls. For details, refer to each individual category for making calls.

1 Press .

The outgoing method list is displayed.

2 Turn the Rotary encoder to select the outgoing mode.

Setting contents:

Dialed / Received / Missed / Phone Book

Dialed:

Dialed history

Received:

Received history

Missed:

Missed incoming history

Phone Book:

Smartphone phone book

3 Press /ENTER.

The outgoing mode is activated, and each mode list is displayed.

Note

- It may take some time for the list to be displayed, and also directly after connection, the list may not be brought up to date.



4 Turn the Rotary encoder to select a name or a telephone number from the list.

Note

- You can use Phone book alphabet search function to search a name or number from Phone Book. For details, refer to "Phone book Alphabet Search Function" on page 33.

5 Press /ENTER.

The selected telephone number will be called.

If one name has several numbers registered in the telephone book, press  /ENTER after selecting the name*, then turn the Rotary encoder to choose the desired number and press  /ENTER, the telephone will be called.

- * If the name cannot be recognized, "NO Name" will be displayed.

Notes

- Press  to return to the previous mode.
- If no operation is performed for 60 seconds, the unit will return to normal mode automatically.

Redialing a Number In Outgoing History

Previously dialed telephone numbers (maximum number of call record is 20) are stored in dialed calls history. You can redial a number by searching from dialed calls history.

Setting item: Dialed

Dialing a Number In Incoming History

Telephone numbers (maximum number of call record is 20) from received calls are stored in the Received List. You can redial these numbers by searching here.

Setting item: Received

Dialing a Number In Incoming Missed Call History

Telephone numbers (maximum number of call record is 20) for received calls that are missed, are stored in the Missed List. You can redial these numbers by searching here.

Setting item: Missed

Dialing a Number In The Phone Book

Up to 1,000 names (at most 3 telephone numbers for each name) are downloadable from a Smartphone. Dial a call by selecting a person from the phone book list.

Setting item: Phone Book

Notes

- The order of the list display depends on the setting of "PB Order" (refer to "Changing the Phone book List Order" on page 31).
- If the call history or phone book of the Smartphone is added or deleted while it is connected to the unit, the list displayed on the unit may not be brought up to date. If it is not updated, you cannot correctly place a call.
- You can display the information of a number stored in phone book by pressing  VIEW. Each press changes the display as Name → Telephone NO./Telephone label* → Name. If the information cannot be obtained, "NO Name" or "NO Number" will display.
- * The telephone label of a number depends on the number information stored in Phone book of the Smartphone, which includes 4-type icons-(Mobile), (Home), (Work), and (Other).

Phone book Alphabet Search Function

You can select the first three letters to search for a desired name in phone book list by using the Phone book alphabet search function.

For example:

Searching a name "Michael James"

The following example explains how the search is performed.

Depending on the setting in PB Order (refer to "Changing the Phone book List Order" on page 31), the phone book is listed in first name or last name order. Please search for the first name or last name according to the setting.

1 Press ABC SEARCH while in the phone book list, the phone book alphabet search mode is activated.

The letter selection screen is displayed.

2 Turn the Rotary encoder to select the first letter (e.g. M), and then press .

3 Turn the Rotary encoder to select the second letter (e.g. J), and then press .

4 Turn the Rotary encoder to select the third letter (e.g. C), and then press **Q** /ENTER.

The names stored in phone book which begin with "MIC" are searched.

5 Turn the Rotary encoder to select the desired name (e.g. Michael James), and then press **Q** /ENTER to make the call.

Notes

- If the selected name has several numbers registered in phone book, you need to turn the **Rotary encoder** to select the desired number, and then press **Q** /ENTER.
- Press **◀** in step 3 or 4 to delete the current entry and return to the previous step.
- You can search for a name by its first letter, first two letters or first three letters. Press **Q** /ENTER after entering the desired number of letters. A list displays the names beginning with the entered letter(s).

Call waiting function

If a second call is received during a current call, you can have the first caller wait momentarily while you take the second call. When you are finished with one call, you can switch to the other one.

If a second call is received during the current call (call1), the information of second caller (call2) is displayed instead of the current caller's name. Press **▶ 2, the call waiting mode is activated.**

In this case, call1 is on hold, while you take call2.

Notes

- In the call waiting mode, press **1 ◀** or **▶ 2** to switch between the current call and the person on hold.
- In the call waiting mode, press and hold **1 ◀** or **▶ 2** for at least 2 seconds to hang up call1 or call2, and the other call will be answered automatically. The action depends on the paired device.
- In the call waiting mode, you can press **VIEW** to change the display between waiting number (1 or 2) and caller name.

Preset a number in the Phone Menu (Shortcut dial)

Assign numbers that you dial frequently to presets for quick recall. You can assign up to six frequently called phone numbers to number presets.

Select a number you want to preset from the Phone Menu list (Phone Book, Dialed Call, etc.). Press and hold any one of the preset buttons (1 through 6) for at least 2 seconds as the one that you wish to store the number for at least 2 seconds.

The phone number you selected is stored in presets.

Notes

- If the name has several numbers registered in the phone book, press **Q** /ENTER after selecting the name. Turn the **Rotary encoder** to choose the desired number. Press and hold any one of the **preset buttons (1 through 6)** for at least 2 seconds. The selected number is stored as a preset number.
- A total of 18 phone numbers can be stored in the preset memory (6 numbers for each Smartphone in the paired device list). If a Smartphone is deleted from the paired device list, the stored preset numbers of this Smartphone are deleted, even when it is paired again.
- If you store a phone number in a preset with a previously stored number, the current number will be cleared and replaced by the new one.

Dialing the preset number

1 Press any one of the preset buttons (1 through 6) that has had a number stored in the phone mode.

The information (name/number) stored in the preset station is displayed.

2 Press **Q** /ENTER or press **↶**.

The stored preset number is dialed directly.

Adjusting the volume when receiving a Call

While calling, you can adjust the volume.

Turn the Rotary encoder to adjust the volume.

Note

- You may need to increase volume from your regular audio listening source level. However, increasing the volume excessively may result in feedback. Feedback is directly related to the volume. Turning down the volume as low as acceptable, will reduce it. Positioning the microphone in a direction away from the main car speakers (e.g. clipped on sun visor) may also reduce feedback at high volume.

Muting the microphone input quickly (Voice Mute)

While calling, activating the Voice Mute function will instantly mute the microphone input. Your voice will not be heard by the caller.

While calling, press **▶/II to mute the microphone input.**

Press **▶/II** again will bring the microphone input back to its previous volume level.

Call Switching Operation

While making a call, this function allows you to initiate the transfer of the audio between the Smartphone and the speakers in the car.

While calling, press **BAND or press and hold **▶/II** for at least 2 seconds to switch the call sound between the unit and Smartphone.**

Note

- Depending on the Smartphone, this operation may not be performed.

Bluetooth Audio Operation

Audio information of a BLUETOOTH compatible Smartphone, a portable player, etc., is controllable/playable wirelessly* from this unit.

- * To play back audio, a Smartphone or a portable player conforming to A2DP (Advanced Audio Distribution Profile) and AVRCP (Audio/Video Remote Control Profile) is required.
Not all functions work with all devices.

Notes

- Set "Bluetooth IN" to ON when you want to use Bluetooth Audio function. Refer to "Setting the BLUETOOTH Connection (Bluetooth IN)" on page 30.
- During a call, sound on the BLUETOOTH audio source is muted.
- If you operate the Hands-free phone (e.g. searching in the phonebook) while using the Bluetooth Audio function, BLUETOOTH Audio playback may be affected.

Recalling the Bluetooth Audio Mode

Press **Q** /SOURCE to select the BLUETOOTH Audio mode.

Selecting the desired Song

- 1 Press **I◀◀**.
Returns the beginning of the song being played back.
- 2 Press **▶▶I**.
Forwards the next song.
Pressing and holding **I◀◀** or **▶▶I** will fast backward/fast forward track continuously.

Note

- The action depends on the paired device.

Pausing

Press **▶/II**.

A playback stops. Pressing again will resume a playback.

Selecting the desired Group (Folder)

Press **1 ◀** or **▶ 2** to select the desired Group (Folder).

Pressing and holding **1 ◀** or **▶ 2** will change folders continuously.

Note

- This function may not available depending on the paired device.

Searching for a desired song

Artist name, album name, etc., may be searched and displayed during playback or pause.

- 1 Press **Q** /ENTER to activate the search mode.
- 2 Turn the **Rotary encoder** to select the desired Group (Folder), and then press **Q** /ENTER.
- 3 Turn the **Rotary encoder** to select the desired album, folder, etc., within the selected Group (Folder), and then press **Q** /ENTER.
- 4 Repeat step 3 if necessary until the desired song is found.

Notes

- Search mode may differ depending on the connected device.
- The pause mode may be canceled after the search.
- This function may not available depending on the paired device.

Flash Memory (optional)

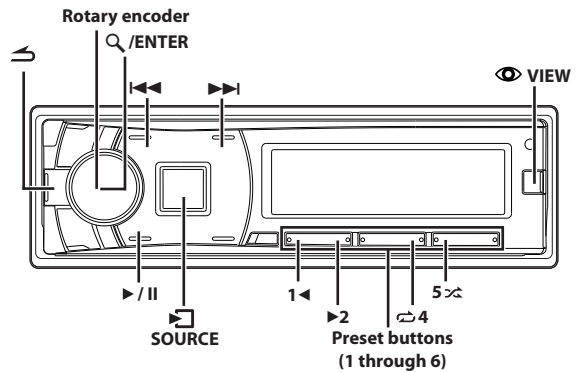

Connecting the Flash Memory (optional)

If a Flash Memory device is connected to the unit, MP3/WMA/AAC files can be played back.

Playback

- 1 Press **Q** /SOURCE to select the USB mode.
- 2 Press **I◀◀** or **▶▶I** to select the desired track (file).
Pressing and holding **I◀◀** or **▶▶I** will fast backward/fast forward track continuously.
- 3 To pause playback, press **▶/II**.
Pressing **▶/II** again will resume playback.

Notes

- Any file protected by DRM (Digital Rights Management) copy protection, cannot be played back on this unit.
- The playback time may not be correctly displayed when a VBR (Variable Bit Rate) recorded file is played back.
- If there is tag information, artist name/album name/song name is displayed.
- If an MP3/WMA/AAC file contains ID3 tag/WMA tag information, the ID3 tag/WMA tag information is displayed (e.g., song name, artist name, and album name). All other tag data is ignored.
- If text information is not compatible with this unit, the display is blank.
- Before disconnecting Flash Memory, be sure to change to another source or set to pause.
- Press **VIEW** to switch the display. For details, refer to "Displaying the Text" on page 22.

Repeat Play

1 Press 4.

The song is played back repeatedly.

RPT*¹ → RPT*² → (off) → RPT

*1 Only a file is repeatedly played back.

*2 Only files in a folder are repeatedly played back.

2 To cancel repeat play, select (off) with the above procedure.

Note

- During repeat play, setting M.I.X. to ON will cancel the repeat play.

M.I.X. (Random Play)

1 Press 5 .

The songs are played back in random sequence.

MIX*¹ → MIX ALL*² → (off) → MIX□

*1 All songs in the current folder are played back in random sequence. Any one song does not play back again until all songs have been played back.

*2 All songs in the Flash Memory are played back in random sequence. Any one song does not play back again until all songs have been played back.

2 To cancel M.I.X. play, select (off) with the above procedure.

Notes

- When a song is played back during Random (M.I.X.) play in the USB mode, the song can be played back again randomly even if not all songs in the Flash Memory have been played back.
- During M.I.X. play, setting repeat play to ON will cancel the M.I.X. play.
- During repeat play, etc., the track number display for M.I.X. play may be incorrect.

Searching for a desired Song

Flash Memory can contain hundreds of songs. By organizing songs by folder, you can quickly find a desired folder/file. This operation is similar to search a folder/file from PC.

1 Press /ENTER to activate the search mode.

2 Turn the Rotary encoder to select a desired folder/file.

3 Press /ENTER to play the selected file or enter the selected folder.

Press and hold  /ENTER for at least 2 seconds to play back all songs in the selected folder.

4 If a folder is opened in Step 3, Repeat Steps 2 to 3 until the desired folder/file is found.

Notes

- If no operation is performed for 60 seconds, the search mode is canceled.
- The root folder of Flash Memory is displayed as "ROOT".
- In the search mode, pressing  will return to the previous mode.
- When search is made during M.I.X. play, the M.I.X. play mode will be canceled.
- If any one of the preset buttons (1 through 6) is pressed in the search mode, a search can be made quickly by skipping to the specified location. For details, refer to "Direct Search Function" on page 38.

- In the search mode, a search can be made quickly by USB Skip function to find the desired folder/file. For details, refer to "Setting the USB Skip function" on page 28.
- The total folders/files should be less than 1,000 (512 files for root folder) in each search hierarchy.

Select Folder

Folder can be easily changed. For example, if you listen to a song from a selected folder, the folder can be changed.

Press 1  or  2 to select the desired Folder.

Note

- This function is inactive during MIX ALL playback.

Search Position Memory

During playback, you can quickly return to the last-selected hierarchy level in the search mode.

Press .

The hierarchy you selected last in the search mode is displayed.

iPod/iPhone (optional)

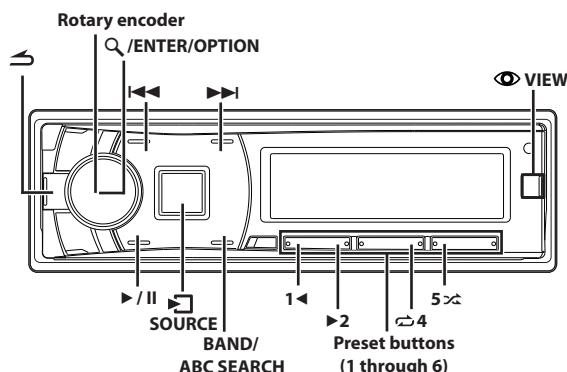

Connecting an iPod/iPhone

An iPod/iPhone can be connected to this unit by using the Interface cable for iPod (included with iPod/iPhone). When this unit is connected by using the cable, the controls on the iPod are not functional.

Notes

- Internet and telephone functions of the iPod touch or iPhone, etc., can also be used while connected to this unit. However, using these functions will stop or pause the playing songs. Stop using any applications or the phone functions before going back to music playback on your device.
- If you connect an iPhone to this unit, it can be used as an iPod. If you use iPhone as a hands-free phone, use the unit in which the BLUETOOTH function is built.

About iPod/iPhone models usable with this unit

- Confirmed devices regarding Made for iPod. Correct function of earlier versions cannot be guaranteed.
 - iPod touch (4th generation): Ver.5.1.1
 - iPod nano (6th generation): Ver.1.2
 - iPod touch (3rd generation): Ver.5.1.1
 - iPod nano (5th generation): Ver.1.0.2
 - iPod classic (160 GB) (Late 2009): Ver.2.0.4
 - iPod touch (2nd generation): Ver.4.2.1
 - iPod nano (4th generation): Ver.1.0.4
 - iPod classic (120 GB): Ver.2.0.1
 - iPod touch (1st generation): Ver.3.1.3
 - iPod nano (3rd generation): Ver.1.1.3
 - iPod classic (80 GB, 160 GB): Ver.1.1.2
- Confirmed devices regarding Made for iPhone. Correct function of earlier versions cannot be guaranteed.
 - iPhone 4S: Ver.5.1.1
 - iPhone 4: Ver.5.1.1
 - iPhone 3GS: Ver.5.1.1
 - iPhone 3G: Ver.4.2.1
 - iPhone: Ver.3.1.3
- For clarity in identifying your model of iPod, please see Apple's own document "Identifying iPod models" at <http://support.apple.com/kb/HT1353>
- This unit does not support video playback from iPod/iPhone, even using a video-compatible cable.

Setting the iPod Control

When an iPod/iPhone is connected, operate it from its own controls or from the head unit.

- 1 Press and hold **Q/ENTER/OPTION** for at least 2 seconds in the iPod mode.

The Option menu for iPod mode is activated.

- 2 Turn the **Rotary encoder** to select "APP Direct", and then press **Q/ENTER**.

The iPod control mode will switch between iPod Mode and HU Mode.

HU Mode (HEAD UNIT):

Operate the iPod/iPhone via this unit.

iPod Mode:

Operate the iPod/iPhone using its own controls. When iPod is selected, some functions will not be operable via the head unit.

Notes

- During HU Mode, you can switch to iPod Mode directly by pressing **BAND**.
- Once the control mode is changed, this will set pause status, press **▶/||** to continue.
- Depending upon the iPod used, iPod control may not be selectable. Or, if iPod is selected, operation must still be from the head unit.

Playback

- 1 Press **◀/SOURCE** to switch to the iPod mode.

- 2 Press **◀◀** or **▶▶** to select the desired song.

Pressing and holding **◀◀** or **▶▶** will fast backward/fast forward the current song.

- 3 To pause playback, press **▶/||**.

Pressing **▶/||** again will resume playback.

Notes

- A song playing on the iPod/iPhone while it is connected to this unit will continue to play from where it was paused after disconnection.
- If you listen to an episode from a selected podcast or audiobook, the episode can be changed by pressing **1 ◀** or **▶ 2**.
- An episode may have several chapters. The chapter can be changed by pressing **◀◀** or **▶▶**.

Searching for a desired Song

An iPod/iPhone can contain hundreds of songs. This unit utilizes various methods to make searches for desired content as simple as possible. Each music category has its own individual hierarchy as shown below. Choose a music category from the list below to narrow searches quickly.

Hierarchy 1	Hierarchy 2	Hierarchy 3	Hierarchy 4
Playlist	Song	—	—
Artist*	Album*	Song	—
Album*	Song	—	—
Song	—	—	—
Podcast	Episode	—	—
Genre*	Artist*	Album*	Song
Composer*	Album*	Song	—
Audiobook	—	—	—
Genius Mix list	—	—	—

For example:

Searching by Artist name.

The following example explains how an Artist search is performed.

Another search mode can be used for the same operation, although the hierarchy differs.

- Press **Q** / **ENTER** to activate the search selection mode.
- Turn the **Rotary encoder** to select the **Artist** search mode, and then press **Q** / **ENTER**.
Shuffle All^{*1} ↔ Playlist ↔ Artist ↔ Album ↔ Song ↔ Podcast ↔ Genre ↔ Composer ↔ Audiobook ↔ Genius Mix^{*2/*3} ↔ Shuffle All^{*1}

*1 Refer to "Random Play Shuffle (M.I.X.)" on page 39.
*2 Depending on the connected iPod/iPhone, Genius Mix function may not be supported.
*3 When an iPod/iPhone with Genius Mix list created by iTunes is connected to this unit, Genius Mix search mode can be used to search a Genius Mix list.
- Turn the **Rotary encoder** to select the desired **Artist**, and then press **Q** / **ENTER**.
- Turn the **Rotary encoder** to select the desired **Album**, and then press **Q** / **ENTER**.
- Turn the **Rotary encoder** to select the desired **Song**, and then press **Q** / **ENTER**.
The selected song is played back.

Notes

- After pressing and holding **Q** / **ENTER** for at least 2 seconds while in each hierarchy (except Song, Audiobook and Genius Mix list hierarchy), all songs of the selected hierarchy are played back.
- After selecting [All] in the search mode, press and hold **Q** / **ENTER** for at least 2 seconds to play back all songs in the iPod/iPhone or selected search mode.
- If no operation is performed for 60 seconds, the search mode is canceled.
- In the search mode, pressing **↩** will return to the previous mode.
- When search is made during M.I.X. play, the M.I.X. play mode will be canceled.
- "No Song" will be displayed if there are no songs in the selected playlist in the Playlist search mode.
- "No Podcast" will be displayed if there is no podcast data in the iPod/iPhone in the Podcast search mode.
- "No Audiobook" will be displayed if there is no audiobook data in the iPod/iPhone in the Audiobook search mode.

- "No Genius" will be displayed if there is no genius mix list data in the Genius Mix search mode.
- If "iPod name" stored in the iPod/iPhone is selected in the desired Playlist search mode, and **Q** / **ENTER** is pressed, you can search for all songs in the iPod/iPhone. Also, if you press and hold **Q** / **ENTER** for at least 2 seconds, all songs in the iPod/iPhone are played back.
- Depending on the iPod/iPhone, podcast search is not supported.
- During search mode, a search can be made quickly by Alphabet search function to find the desired artist or song, etc. For details, refer to "Alphabet search function" on page 39.
- If any one of the **preset buttons (1 through 6)** is pressed in the search mode, a search can be made quickly by skipping to the specified location. For details, refer to "Direct Search Function" on page 38.
- During search mode, a search can be made quickly by Alphabet search function to find the desired artist or song, etc. For details, refer to "Alphabet search function" on page 39.

Direct Search Function

Direct search can be used to jump a fixed percentage of titles within the current search category (album, song, etc.).

In the search mode, press any one of the preset buttons (1 through 6) to quickly skip over a designated percent of your song content.

Song search example:

If there are 100 songs in your iPod/iPhone, they are divided into 6 groups using percentages (shown below). These groups are assigned to preset buttons 1 through 6.

Example 1:

Suppose the song you are searching for is located at around the middle (50%) of your library: press button 4 to jump to the 50th song and turn the **Rotary encoder** to find the desired song.

Example 2:

Suppose the song you are searching for is located near the end (83%) of your library: press button 6 to jump to the 83rd song and turn the **Rotary encoder** to find the desired song.

	All 100 songs (100%)					
	0%	17%	33%	50%	67%	83%
Preset buttons	1	2	3	4	5	6
Songs	1st song	17th song	33rd song	50th song	67th song	83rd song

Notes

- This function is also applicable to CD/MP3/WMA/AAC search.
- This function is inactive during Alphabet Search mode.
- This function is unavailable when Genius Mix list is selected.

Change Playlist/Artist/Album/Genre/Composer/Episode

Playlist/Artist/Album/Genre/Composer/Episode can be easily changed. For example, if you listen to a song from a selected album, the previous or next album can be selected.

Press 1 ◀ or ▶ 2 to change to the previous or next Playlist/Artist/Album/Genre/Composer/Episode.

Notes

- If the song search mode was used to select a song, this function is inactive.
- If an album is selected during an artist search, other albums by that artist are searchable.
- This function is inactive during shuffle (M.I.X.) playback.

Alphabet search function

Use the alphabet search function to search for an album, song, etc., by its first letter. Select the first letter of the desired title (album, song, etc.), and the titles beginning with this letter are listed.

1 In the search mode, press ABC SEARCH.

The letter selection list is displayed.

2 Turn the Rotary encoder to select a desired letter (e.g. M), and then press Q / ENTER.

The titles beginning with "M" are listed.

3 Turn the Rotary encoder to select the desired title.

Notes

- While in Alphabet search mode, pressing ↵ will return to the previous mode.
- If the Playlist search mode is used to search for a song, the Alphabet search function is inactive in the song search hierarchy.
- This function is unavailable when Genius Mix list is selected.

Search Position Memory

During iPod/iPhone playback, you can quickly return to the last-selected hierarchy level in the search mode.

Press ↵.

The hierarchy you selected last in the search mode is displayed.

Random Play Shuffle (M.I.X.)

The Shuffle function of the iPod/iPhone is displayed as M.I.X. on this unit.

Shuffle Albums:

The songs on each album are played back in proper order. Upon completion of all the songs on the album, the next album is selected randomly. This continues until all albums have been played.

Shuffle Songs:

Song shuffle randomly plays back songs within a selected category (playlist, album, etc.). The songs within the category are played just once until all songs have been played.

1 Press 5 ⌘.

The songs are played back in random sequence.

MIX *1 → MIX *2 → (off) → MIX

*1 Shuffle Albums.

*2 Shuffle Songs.

2 To cancel M.I.X. play, select (off) with the above procedure.

Note

- If a song is selected in the album search mode before selecting M.I.X. play, the songs will not play back randomly even when Shuffle Albums is selected.

Shuffle All:

Shuffle All plays all songs in the iPod/iPhone randomly. Any one song does not play back again until all songs have been played back.

1 Press Q / ENTER to activate the search selection mode.

2 Turn the Rotary encoder to select Shuffle All, and then press Q / ENTER.

To cancel M.I.X. play, press 5 ⌘ to select OFF.

Note

- If Shuffle All is selected, the selected songs being played back in the search mode are canceled.

Repeat Play

Only Repeat One is available for the iPod/iPhone.

Repeat One:

A single song is repeatedly played back.

1 Press 4.

The song is played back repeatedly.

RPT* → (off) → RPT

* Repeat One.

2 To cancel repeat play, select (off) with the above procedure.

Note

- Depending on the connected iPod, track up/down may be not available during Repeat play.

Displaying the Text

You can display the tag information of a song in the iPod/iPhone.

Press  **VIEW**.

Each press changes the display.

Note

- When the Text Scroll is set to Manual (refer to "Scroll Setting (Text Scroll)" on page 27), press and hold  **VIEW** for at least 2 seconds, the current text will be scrolled one time.

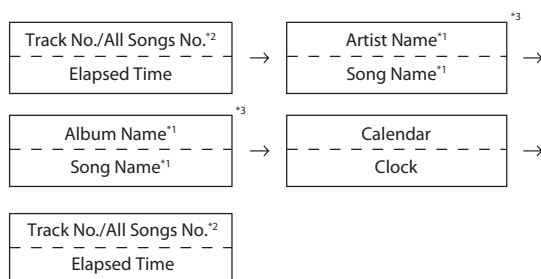

*1 TAG information

If the Text Scroll (refer to "Scroll Setting (Text Scroll)" on page 27) is set to "Auto," the tag information will scroll automatically.

If there is no text information, nothing will be displayed.

*2 The numbers of all songs displayed vary depending on the songs selected by the search.

*3 When the Text Scroll (refer to "Scroll Setting (Text Scroll)" on page 27) is set to "Auto," the display cannot be switched by pressing **VIEW**. The display contents switch alternately.

Notes

- Only alphanumeric characters (ASCII) can be displayed.
- The maximum number of characters for the head unit is 64 (64 byte).
- Some characters may not be correctly displayed.
- The display is blank when text information is not compatible with this unit.

Pandora[®] internet radio (Optional)

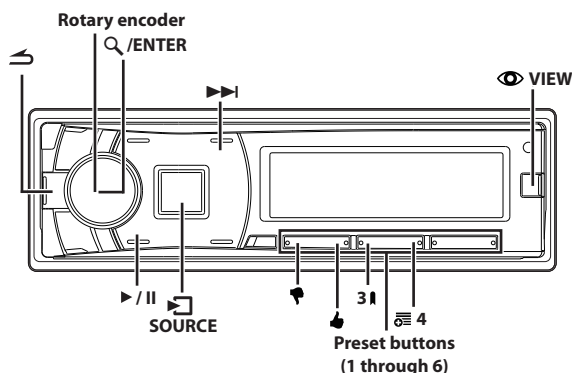

Pandora[®] internet radio is your own FREE personalized radio now available to stream music on your Smartphone (which runs Android OS or iOS).





Just start with the name of one of your favorite artists, songs or classical composers and Pandora[®] will create a "station" that plays their music and more music like it.

The unit enables you to interact with your Pandora[®] account by connecting a Smartphone that has the latest version of the Pandora[®] application installed.

Notes

- Some Pandora[®] application functions are not available when using this unit.
- Pandora[®] is also controllable from an iPod touch with Wi-Fi connection.
- Pandora[®] is available on iOS and Android OS with this unit.
- Before this operation, set ALPINE APP to USB or BT depending on the connected Smartphone. For details, refer to "Application Setting (APP)" on page 28.

Listening to Pandora[®]



- Launch the Pandora[®] Application on the Smartphone.
- Press  /SOURCE to switch to the Pandora mode.
- To pause playback, press . Pressing  again will resume playback.
- To skip to the next song, press .





Notes

- The operation to replay a previous song is not available.
- Pandora[®] limits the number of skips allowed on their service. If you attempt to skip songs beyond the limit, "Skip Limit" is displayed.
- The unit remembers the source just before turning off the power. If Pandora[®] is the last SOURCE to be played, it will appear as the SOURCE the next time the unit is power up even if the app is not launched on your Smartphone.
- Pandora[®] audio could drop out in areas with poor phone coverage.
- The display content varies when ads are received.
- The playback time may not be correctly displayed.

“Thumbs” Feedback

You can personalize your stations with “Thumbs Up” or “Thumbs Down” feedback, which the system takes into account for future music selections.

During playback, press  or  for thumbs up or thumbs down.

-  The “” icon appears in the display. Pandora® will add similar music to your station.
-  The “” icon is displayed. Pandora® will ban that song from your station, and the current song is skipped. If the number of skips allowed has reached its limit, the current song continues to play back.



Note

- In some situations, “Thumbs” feedback may not be available.



Searching for a Desired Station

You can display your station list and select stations directly from this unit.

Alphabet Search:

- Press  /ENTER to activate the Search mode.
- Turn the Rotary encoder to select “A-Z”, and then press  /ENTER.
The “A-Z” search mode is activated and the station names are listed alphabetically.
- Turn the Rotary encoder to select the desired station, and then press  /ENTER.
Pandora® will play that station.

Search by Date Added:



- Press  /ENTER to activate the Search mode.
- Turn the Rotary encoder to select “By Date”, and then press  /ENTER.
The “By Date” search mode is activated and the station names are listed by the date they were added to the account.
- Turn the Rotary encoder to select the desired station, and then press  /ENTER.
Pandora® will play that station.

Note

- If any one of the preset buttons (1 through 6) is pressed in the search mode, a search can be made quickly by skipping the specified number of channels. For details, refer to “Direct Search Function” on page 38.

QuickMix

Use QuickMix to create a playlist based on two or more of your Pandora® stations. Edit your QuickMix station selections on the Pandora® Compatible Application for iPhone when it is not connected to this unit.



- Press  /ENTER to activate the Search mode.
- Turn the Rotary encoder to select “A-Z” or “By Date”, and then press  /ENTER.
The “A-Z” or “By Date” search mode is activated and the station name is displayed.
- Press  /ENTER while selecting “QuickMix”.

Notes

- The songs from the created stations are played back in random sequence.
- Select another station during search mode to cancel QuickMix.

Bookmarking a Desired Song or Artist

The currently playing track or artist can be bookmarked and saved to your Pandora® account.



- During playback, press 3  (Bookmarks).
The Pandora® Bookmark screen is displayed.
- Turn the Rotary encoder to select “Track (Bookmark)” or “Artist (Bookmark)”, and then press  /ENTER.
The current track or artist is bookmarked. “Bookmark Track” or “Bookmark Artist” is displayed.

Notes

- Your bookmarks can be viewed on your “Profile” page at www.pandora.com.
- In some situations, bookmarks may not be available.
- When Bookmark operation is failed, Bookmark N/A will be displayed.

Creating a New Station

Based on currently playing track or artist, you can create a new station and save to your Pandora® account.

- During playback, press  4 (New Station).
The Pandora® New Station screen is displayed.
- Turn the Rotary encoder to select “Track” or “Artist”, and then press  /ENTER.
A “New Track” or “New Artist” pop-up screen.
A New Station based on current track or artist is created.

Notes

- Your New Station can be viewed on your “Profile” page at www.pandora.com.
- In some situations, creating a new station function may not be available.
- If this operation fails, N/A will be displayed.
- When the Smartphone is not connected to this unit, you can create personalized Pandora® stations using the Pandora® Application on your Smartphone. You can also create stations on the web at www.pandora.com.

Search Position Memory

During playback, you can quickly return to the last-selected hierarchy level in the search mode.

Press .

The hierarchy you selected last in the search mode is displayed.

Changing the Display

Press  **VIEW**.

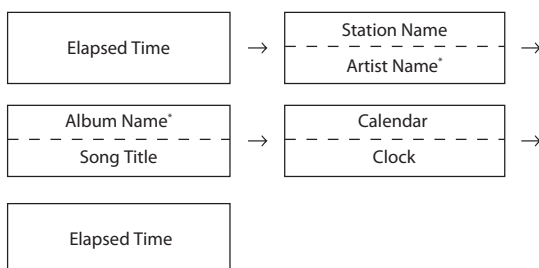





* TAG information
If there is no text information, nothing will be displayed.

Notes

- The maximum number of characters is 64 (64 byte).
- Some characters may not be correctly displayed.

About the indication display

When displaying Text, the following indicators are lit according to the mode.

Indicator/Mode	Pandora Mode
	Station Name being displayed
	Artist Name being displayed
	Album Name being displayed
	Song Name being displayed

SiriusXM Satellite Radio Operation (Optional)

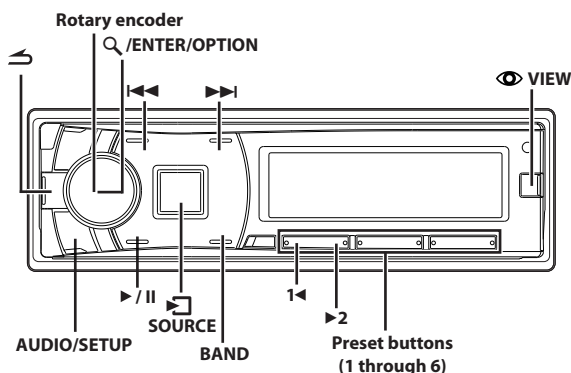

SiriusXM Tuner operation:

When a SiriusXM Tuner is connected to this unit, the following operations may be performed.

Receiving Channels with the SiriusXM Tuner

About SiriusXM Satellite Radio



Everything worth listening to is on SiriusXM. Get over 130 channels, including the most commercial-free music, plus the best sports, news, talk and entertainment. A SiriusXM Tuner and Subscription are required. For more information, visit www.siriusxm.com/activatenow, or call 1-866-635-2349.



To activate SiriusXM Canada service, go www.xmradio.ca and click on "ACTIVATE RADIO" in the top right corner, or call 1-877-438-9677.

Note

- The SiriusXM Satellite Radio controls on this unit are available only when a SiriusXM Tuner is connected.

1 Press  / **SOURCE** to activate the Satellite Radio (SiriusXM) mode.

2 Press  or  to select the desired channel.

Holding down  or  will rapidly browse through the channels.

Alternatively, you can enter the number of the desired channel using the numeric keypad on an optional remote control.

SiriusXM Setting

The following steps 1 to 5 are common to the various SiriusXM functions. For details, refer to each individual function.

- 1 Press and hold **AUDIO/SETUP** for at least 2 seconds to activate the **SETUP** mode.
- 2 Turn the **Rotary encoder** to select "SiriusXM"; and then press **Q/ENTER**.
The SiriusXM setup mode is activated.
- 3 Turn the **Rotary encoder** to select the desired items and then press **Q/ENTER**.
SiriusXM:
Alert Setup ↔ Games Alert Setup ↔ Parental Lock ↔ Signal Indicator ↔ Alert Setup
- 4 Turn the **Rotary encoder** to change the settings.
- 5 Press and hold **AUDIO/SETUP** for at least 2 seconds.
The **SETUP** mode is canceled.

Notes

- Press **↶** to return to the previous mode.
- If no operation is performed for 60 seconds, the unit will return to normal mode automatically.

Managing Artist and Song Alerts

The following operations can be performed to change the Alert settings. The Artist and Song Alerts feature allows you to mark Artists and Songs from the current channel and then the unit alerts you later when the marked Artists or Songs are playing on other channels.

Setting item: Alert Setup

Setting contents:

Alert List / Alert / All Source Alert / Delete All

Alert List

This menu option allows you to enable the Artist/Song alert for individual Artist/Songs (ON or OFF) or to delete individual stored Artist/Song alerts (Delete).

- 1 Turn the **Rotary encoder** to select **Alert List**, and then press **Q/ENTER**.
- 2 Turn the **Rotary encoder** to select a stored **Artist or Song**, and then press **Q/ENTER**.
- 3 Turn the **Rotary encoder** to **Alert** to enable (ON) or disable (OFF) the alert for the selected Artist/Song or turn the **Rotary encoder** to select **Delete** to delete the selected Artist/Song from memory.

Alert

This menu option allows you to temporarily disable the Artist/Song Alerts for all Artists/Songs. When the Alerts are re-enabled, individual Artist/Song Alert disabled in the Alert List menu setting remain disabled.

Turn the **Rotary encoder** to select **ON** or **OFF**, and then press **Q/ENTER**.

If **ON** is set, the alert for all stored Artists/Songs is enabled.
If **OFF** is set, the alert for all stored Artists/Songs is disabled.

All Source Alert

This menu option allows you to enable the alerts of all sources.

Turn the **Rotary encoder** to select **ON** or **OFF**, and then press **Q/ENTER**.

If **ON** is set, the alert of all source is enabled.
If **OFF** is set, only the alert of SiriusXM source is enabled.

Delete All

This operation will delete all alerts (artists, songs and team) stored in memory.

After selecting this item,

Turn the **Rotary encoder** to select **YES**, and then press **Q/ENTER**.

Setting the Favorite Sports Team Alerts

This menu option allows you to select your favorite teams, organized by leagues, so that you will be alerted later when your favorite teams are playing on other channels.

Setting item: Games Alert Setup

After selecting Games Alert Setup, a sports league list will be displayed.

- 1 Turn the **Rotary encoder** to select the desired league, and then press **Q/ENTER**.
- 2 Turn the **Rotary encoder** to select a team you want to store, and then press **Q/ENTER**.
A "Team Saved" pop-up screen is followed by an "X U(sed)/Y E(mpty)".
X is the total number of Artist/Song/Game alert items stored in memory, and Y is the total number of memory slots still available for storage.

Note

- Select "None" on the team list if you do not want to store in memory.

Setting the Parental Control

You can lock out channels with passcode protection. Channels that are locked cannot be accessed without entering the passcode. You can unlock a channel or change the passcode using this menu option.

Setting item: Parental Lock

Setting contents:

Clear All / Locked Channels / Edit Code

How to input passcode?

- 1 After select **Parental Lock**, a passcode input screen will be displayed.
- 2 Input the passcode using the **Rotary encoder**.
The initial default 4-digit passcode is set to 0000. The passcode is entered one digit at a time with the **Rotary encoder**.
For example, by turning to clockwise 2 steps, the number 1 is selected. After entering the digit, it is displayed as "*" (asterisk).
- 3 Press **▶▶**, and then input the next digit of the passcode as described in step 2.
Press **◀◀** to delete the current entry return to the previous step.
- 4 Repeat steps 2 to 3 until the 4 digits of the passcode are entered, and then press **Q/ENTER**.

After the correct passcode is entered, the Clear All/Locked Channels/Edit Code items can be adjusted.

Clear All:

Unlock all locked channels.

Turn the **Rotary encoder** to select **YES**, and then press **Q/ENTER**.

Locked Channels:

After selecting this item, turn the **Rotary encoder** to select a channel from channel list, press **Q/ENTER** to select to lock or unlock the channel. Locked channels cannot be tuned without entering the passcode.

The locked channel will be displayed with "L" before channel No.

Edit Code:

Change the passcode.

- 1 **Input the old passcode as steps 1 to 4 in “How to input passcode?”.**
After the old passcode is entered, the new passcode input screen will be displayed.
- 2 **Input the new passcode as steps 1 to 4 in “How to input passcode?”.**
A confirm screen will be displayed and the new passcode must be entered again for confirmation.
When the passcode is changed successfully, the unit will display Code Saved.

Note

- Keep a note of the numbers somewhere safe in case you should forget it.

Confirming the strength of the SiriusXM signal

You can check the signal strength through this setting item.

■ **Setting item:** Signal Indicator

Setting content:

Signal Indicator

Signal Indicator:

This menu item displays the SiriusXM signal strength as Strong, Good, Weak or No Signal.

Note

- If the Signal Indicator reports Weak or No Signal and your vehicle is parked outside with no obstructions to the southern sky, then your SiriusXM antenna may not be properly installed or may have become damaged.

Checking the SiriusXM Radio ID Number

To subscribe to the SiriusXM Satellite Radio service, it is necessary to locate and identify the Radio ID of your SiriusXM Tuner. The Radio ID contains 8 characters and can be found on the bottom of your SiriusXM Tuner or can be displayed on when selecting Channel 0 by following the steps below:

- 1 **While in the Satellite Radio Mode, press **◀◀** or **▶▶** to select channel “0”.**

The unit displays “RADIO ID” and ID number at the same time.

Note

- The Radio ID does not include the letters I, O, S or F.

- 2 **To cancel the ID number display, select a channel other than “0”.**

Storing Channel Presets

- 1 **Press **BAND** to select the desired band you want to store the preset in.**

There are 3 Satellite Radio Preset bands.

Each press of **BAND** changes the band: SiriusXM1 → SiriusXM2 → SiriusXM3 → SiriusXM1

- 2 **Tune to the desired channel, and then press and hold (for at least 2 seconds) one of the preset buttons (1 through 6) to store the channel.**

The display then shows the stored Band and preset number (for example, SiriusXM1-3 is shown when preset 3 of BAND1 is selected).

- 3 **Repeat the procedure to store up to 5 other channels onto the same band.**

Notes

- A total of 18 channels can be stored in the preset memory, 6 Channels for each band (SiriusXM1, SiriusXM2 and SiriusXM3).
- If you store a new channel into a preset which already has a channel assigned, the current channel will be cleared and replaced with the new one.

Tuning Channels using Presets

- 1 **Press **BAND** to select the desired band of Presets you wish to access.**
- 2 **Press the preset buttons (1 through 6) that has your desired Satellite Radio channel stored in memory.**

Storing the desired Artist and Song Alerts

While listening to SiriusXM Satellite Radio, you can be alerted when your favorite songs or artists are playing on other channels. An interruption Alert will be displayed when a matching artist or song is found on another channel. For receiving interruption Alert information, refer to “Receiving and Tuning to an Alert” on page 45.

- 1 **Press and hold **Q/ENTER/OPTION** for at least 2 seconds when a Song or the song of an Artist you want to store is playing.**

The Option mode is activated.

- 2 **Turn the Rotary encoder to select Alert Memory, and then press **Q/ENTER**.**

- 3 **Turn the Rotary encoder to choose Save Artist? or Save Song? (when available), and then press **Q/ENTER**.**

Note

- If both the artist name and song title are not available to save, Artist/Song will be displayed.

- 4 **The new alert was stored in memory.**

An “Artist/Song Saved” pop-up screen is followed by an “X U(sed)/Y E(mpty)”.

X is the total number of song titles or artist names stored in memory, and Y is the total number of memory locations still available for storage.

Notes

- If you try to store when the memory is full, “Memory Full” is displayed followed by “Replace/Cancel”. If you want to replace an existing alert item, select “Replace” by turning **Rotary encoder**, and then press **Q/ENTER**, the existing alert list stored in memory is displayed. Select one of the stored alerts using the **Rotary encoder**. To replace the selected alert, press **Q/ENTER** and an “Artist/Song Saved” pop-up screen is followed by an “X U(sed)/Y E(mpty)”.
- You can manage the stored Alert memory setting on Setup mode, for details, refer to “Managing Artist and Song Alerts” on page 43.
- If no operation is performed for 60 seconds, the setting mode is canceled.

Receiving and Tuning to an Alert

Whenever a stored sports team, artist, or song is playing on another channel, an interruption Alert appears on the unit display. To tune to the game, artist or song identified by the alert, follow the steps below:

1 Turn the **Rotary encoder** to select the desired game, artist or song from the list of active alerts.

2 Press **Q/ENTER**.

Notes

- If no operation is performed for 5 seconds, the unit returns to normal mode.
- Sports teams/Artist name and Song title which you have stored and which are currently playing will be displayed in a category called "My Music"/"My Games" in search mode. For details, refer to "Search Function" on page 45.

Search Function

You can search for SiriusXM programming content by Category or by Channel.

1 Press **Q/ENTER** in the SiriusXM mode.

2 Turn the **Rotary encoder** to select the desired Category, and then press **Q/ENTER**.

3 Turn the **Rotary encoder** to select the desired Channel Name, and then press **Q/ENTER**.

Searching by Channel

1 Turn the **Rotary encoder** to select All Channels after step 1, and then press **Q/ENTER**.

All Channels will be displayed in a list.

2 Turn the **Rotary encoder** to select the desired channel, and then press **Q/ENTER** to confirm.

Note

- Press **VIEW**, the information of the broadcasting channels will be displayed. You can choose the desired channel from the artist name list or song name list.

Each time you press **VIEW**, the display changes as below.

Channel number/Channel name → Channel number/Artist name → Channel number/Song name → Channel number/Channel name

Note

- During channel search, pressing **1** ◀ or ▶ **2** to select another Category.

Searching by My Music

1 Turn the **Rotary encoder** to select My Music* after step 1, and then press **Q/ENTER**.

The artist names and song names that you have stored and are currently playing will be displayed in a list.

* Displayed only when the stored song or artist is broadcasting.

2 Turn the **Rotary encoder** to select the desired artist/song, and then press **Q/ENTER** to confirm.

The channel of the selected artist/song being broadcast is received.

Note

- Press **VIEW**, the information of the broadcasting channels will be displayed. You can choose the desired channel from the artist name list or song name list.

Each time you press **VIEW**, the display changes as below.

Channel number/Channel name → Channel number/Artist name → Channel number/Song name → Channel number/Channel name

Searching by My Games

1 Turn the **Rotary encoder** to select My Games* after step 1, and then press **Q/ENTER**.

The sport teams that you have stored and the game is currently broadcasting will be displayed in a list.

* Displayed only when the game of stored team is broadcasting.

2 Turn the **Rotary encoder** to select the desired team, and then press **Q/ENTER** to confirm.

The channel of the selected game being broadcast is received.

Notes

- The Search mode is canceled if no operation is performed for 60 seconds in Search mode.
- Press **↶** in the search mode to return to the previous mode.

Using Jump Memory and Jump Recall function

1 While in SiriusXM mode, select your favorite SiriusXM Channel.

2 Press and hold **▶/II** for at least 2 seconds.

The channel you selected is stored as the Jump Source.

3 Press and hold **BAND** for at least 2 seconds to recall, and then tune to the saved Jump Source channel.

Notes

- Pressing and holding **BAND** again for at least 2 seconds will jump back to the previous mode or SiriusXM channel.
- During saved Jump Source channel playing, search function, channel up/down, etc. are not available.

Replay Function

In SiriusXM mode, you can pause, rewind and replay of live SiriusXM Satellite Radio.

1 While listening to a SiriusXM channel, press ►/|| to enter the Replay mode, which mutes the audio.

The display will show "PAUSE" while in this mode.

2 Press ►/|| again to resume playback of the stored audio from the point at which it was paused.

During playback, the SiriusXM Tuner will continue to store the channel audio until you exit the Replay mode.

During REPLAY playback:

- Fast rewind:
Press and hold ◀◀.
- Fast forward:
Press and hold ▶▶.
- Returning to the beginning of the current song:
Press ◀◀.
- Advancing to the beginning of the next song:
Press ▶▶.

Notes

- If you continue to press Fast forward until the end, the Replay mode is canceled, and the unit will change to live SiriusXM radio mode.
- If you change channels while in Replay mode, the unit will exit Replay mode to live Satellite Radio mode and clear the Replay memory.

3 Press ⏏ to cancel the REPLAY mode.

The unit returns to live SiriusXM radio mode.

Parental Lock Function

This function can help restrict the listening of channels to children of appropriate age levels only. For information on setting the Parental Control passcode, refer to "Setting the Parental Control" on page 43. When a locked channel is selected, a "Channel Locked" pop-up screen is displayed.

Input the 4-digit passcode you set in, and then press Q/ENTER, refer to "Setting the Parental Control" on page 43.

Turn the **Rotary encoder** to select the number from 0-9, and then use ◀◀ or ▶▶ to adjust the digit.
The initial number is 0000.

Notes

- If you input a wrong passcode, "Wrong Code" is displayed.
- After entering the correct passcode, you can access all locked channels without entering the passcode again until the unit is powered off and then back on.

Storing iTunes Tagging information

iTunes Tagging lets you tag songs heard on SiriusXM channels. Use this unit in conjunction with an optional SiriusXM Tuner and a Tagging compatible iPod/iPhone to tag the music that you listen to. This tag information is automatically transferred to your iPod/iPhone. Later, when your iPod/iPhone is connected to iTunes, you can preview, buy and download your tagged songs. For details, refer to the Owner's Manual of the Tagging compatible iPod/iPhone.

The **Tag** indicator will light when a song playing on a SiriusXM channel has tag information available.

Press and hold  VIEW for at least 2 seconds to save its tag information.

If no iPod/iPhone is connected, "Tag Count X" is displayed (X is the total amount of the tag information stored in this unit).

Notes

- During tagging, the iPod/iPhone takes priority to save the tag information. If no iPod/iPhone is connected, the tag information is saved to this unit.
- When the memory of iPod/iPhone is full, "iPod Full" and "Tag Count X" are displayed. The tag information will be stored to the unit.
- If the operation is failed, "Cannot Tag" is displayed.
- This unit can store up to 50 tagged songs. When the memory of the unit is full, "Tag Count50" and "Memory Full" are displayed.
- When an iPod that doesn't support the tagging function is connected, "Non-Tagging iPod" is displayed.
- When the iPod/iPhone is disconnected from the unit during tagging, its tag information will be stored in the unit.
- If there is stored tag information on the unit, when an iPod/iPhone supporting the tag function is connected, the stored tag information will be transferred to the iPod/iPhone automatically. When the iPod/iPhone memory becomes full, "iPod Full" will be displayed, and any remaining tag information on the unit will not be transferred to the iPod/iPhone.
- If tag information already exists, "Already Tagged" will be displayed when you try to tag information again.

Changing the Display

Text information, such as the channel name, artist name/feature and song/program title, is available with each SiriusXM channel. The unit can display this text information as explained below.

In SiriusXM mode, press  VIEW.



Each time you press this button, the display changes as shown below.

Channel Number/Channel Name* → Artist Name*/Song Title* → Content info.* /Category Name* → Clock → Channel Number/Channel Name

* If there is no text information, nothing will be displayed.

About the indication display

When displaying Text, the following indicators are lit according to the mode.

Indicator/Mode	SiriusXM Mode
CH	Channel Number being displayed
CH:	Channel Name being displayed
	Artist Name being displayed
	Song Title being displayed
	Content INFO being displayed
CAT	Category Name being displayed

Information

In Case of Difficulty

If you encounter a problem, turn the power off, then on again. If the unit is still not functioning normally, review the items in the following checklist. This guide will help you isolate the problem if the unit is at fault. Otherwise, make sure the rest of your system is properly connected or consult your authorized Alpine dealer.

Basic

No function or display.

- Vehicle's ignition is off.
 - If connected following instructions, the unit will not operate with the vehicle's ignition off.
- Improper power lead (Red) and battery lead (Yellow) connections.
 - Check power lead and battery lead connections.
- Blown fuse.
 - Check the fuse of the unit; replace with the proper value if necessary.
- Internal micro-computer malfunctioned due to interference noise etc.
 - Press the RESET switch with a ballpoint pen or other pointed article.

Radio

Unable to receive stations.

- No antenna or open connection in cable.
 - Make sure the antenna is properly connected; replace the antenna or cable if necessary.

Unable to tune stations in the seek mode.

- You are in a weak signal area.
 - Make sure the tuner is in the DX mode.
- If the area you are in is a primary signal area, the antenna may not be grounded and connected properly.
 - Check your antenna connections; make sure the antenna is properly grounded at its mounting location.
- The antenna may not be the proper length.
 - Make sure the antenna is fully extended; if broken, replace the antenna with a new one.

Broadcast is noisy.

- The antenna is not the proper length.
 - Extend the antenna fully; replace it if it is broken.
- The antenna is poorly grounded.
 - Make sure the antenna is grounded properly at its mounting location.

CD

CD Player not functioning.

- Out of operating temperature range +50°C (+120°F) for CD.
 - Allow the vehicle's interior (or trunk) temperature to cool.

CD playback sound is wavering.

- Moisture condensation in the CD Module.
 - Allow enough time for the condensation to evaporate (about 1 hour).

CD insertion not possible.

- A CD is already in the CD player.
 - Eject the CD and remove it.

- The CD is being improperly inserted.
 - Make sure the CD is being inserted following instructions in the CD Player Operation section.

Unable to fast forward or backward the CD.

- The CD has been damaged.
 - Eject the CD and discard it; using a damaged CD in your unit can cause damage to the mechanism.

CD playback sound skips due to vibration.

- Improper mounting of the unit.
 - Securely re-mount the unit.
- The disc is very dirty.
 - Clean the disc.
- The disc has scratches.
 - Change the disc.
- The pick-up lens is dirty.
 - Do not use a commercially available lens cleaner disc. Consult your nearest Alpine dealer.

CD playback sound skips without vibration.

- The disc is dirty or scratched.
 - Clean the disc; damaged disc should be replaced.

Error displays (built-in CD player only).

- Mechanical error.
 - Press . After the error indication disappears, insert the disc again. If the above-mentioned solution does not solve the problem, consult your nearest Alpine dealer.

CD-R/CD-RW playback not possible.

- Close session (finalization) has not been performed.
 - Perform finalization and attempt playback again.

MP3/WMA/AAC

MP3, WMA or AAC is not played back.

- Writing error occurred. The MP3/WMA/AAC format is not compatible.
 - Make sure the MP3/WMA/AAC has been written in a supported format. Refer to "About MP3/WMA/AAC" on page 15, then rewrite in the format supported by this device.

Audio

The sound is not output from the speakers.

- There is no signal output from the internal amplifier.
 - Power IC is switched to "ON" (refer to "Connecting to an External Amplifier" on page 18).

iPod

iPod does not play and no sound is output.

- The iPod has not been recognized.
 - Reset this unit and the iPod. Refer to "Initial System Start-Up" on page 10. To reset the iPod, refer to the Owner's Manual of the iPod.

Indication for CD Player

No Disc

- No CD is inserted.
 - Insert a CD.
- Although a disc is inserted, "No Disc" is displayed and the unit does not start to play or eject the disc.
 - Remove the disc by following these steps:
 - Press the  button again for at least 2 seconds.
 - If the disc still does not eject, consult your Alpine dealer.

Error

- Mechanism error.
 - 1 Press the **▲** button and eject the CD.
If not ejecting, consult your Alpine dealer.
 - 2 When the error indication remains after ejecting, press the **▲** button again.
If the error indication still does not turn off after pressing the **▲** button for a few times, consult your Alpine dealer.
- When “Error” is displayed:
If the disc cannot be ejected by pressing **▲**, press the RESET switch (refer to “Initial System Start-Up” on page 10) and press **▲** again.
If the disc still cannot be ejected, consult your Alpine dealer.

Protect

- A copy-protected WMA file was played back.
 - You can only play back non-copy-protected files.

Unsupported

- A sampling rate/bit rate not supported by the unit is used.
 - Use a sampling rate/bit rate that is supported by the unit.

Indication for Flash Memory

Error-01

- Database error or decoder error.
 - You can solve the problem by switching the source.

Error-02

- Communication error or boot error, etc.
 - You can solve the problem by reconnecting the Flash Memory or format the USB Memory.

Current Error

- Abnormal current is run to the USB connector device.
 - You can solve the problem by switching the source.

USB Device Error

- A USB device that is not supported by the unit is connected.
 - Connect a USB device that is supported by the unit.

No USB Unit

- A Flash Memory is not connected.
 - Make sure the Flash Memory device is correctly connected and the cable is not excessively bent.

No Song

- No song (file) is stored in the Flash Memory.
 - Connect the Flash Memory device after storing songs (files).

Unsupported

- A sampling rate/bit rate not supported by the unit is used.
 - Use a sampling rate/bit rate that is supported by the unit.

Protect

- A copy-protected WMA file was played back.
 - You can only play back non-copy-protected files.

Indication for iPod Mode

No USB Unit

- The iPod/iPhone is not connected.
 - Make sure the iPod/iPhone is correctly connected (refer to “Connections” on page 54).
Make sure the cable is not bent excessively.

No Song

- There are no songs in the iPod/iPhone.
 - Download songs to the iPod/iPhone and connect to this unit.

Error-01

- Communication error or boot error, etc.
 - You can solve the problem by reconnecting the iPod/iPhone or changing source.

Error-02

- The iPod/iPhone version is too low.
 - Update the iPod/iPhone version.

Error-03

- The iPod/iPhone is not verified.
 - You can solve the problem by reconnecting the iPod/iPhone.

BLUETOOTH mode

No Unit

- The BLUETOOTH device is not connected.
 - Connect the BLUETOOTH device.

SiriusXM Advisory Messages

The following messages may be displayed while operating the unit in SiriusXM mode.

Check Tuner

- The SiriusXM tuner is disconnected or the unit is having trouble communicating with Tuner.
 - Connect the Tuner or check the Tuner connection to the back of the unit.

Check Antenna

- The SiriusXM Satellite Radio antenna or cable is either damaged or not connected correctly to the SiriusXM Tuner.
 - Check that the SiriusXM antenna cable is connected to the SiriusXM Tuner and check that the antenna cable is not kinked or otherwise damaged. Replace the antenna if necessary.
-

No Signal

- The SiriusXM satellite signal is too weak at the current location.
 - Move the vehicle to a location with a clear view of the southern sky.
 - Make sure the Satellite Radio antenna is properly mounted and not obstructed by metal objects.
-

Channel Unsubscribed

- The active channel has become unsubscribed or the requested channel is not available in your subscription package.

Note

- *The unit will revert to the previous selected channel or to channel 1 automatically.*
 - Visit www.siriusxm.com for information on subscribing to this channel.
-

Channel Unavailable

- The active channel is no longer in the SiriusXM channel lineup or the user has entered an invalid channel number.

Note

- *The unit will revert to the previous channel or to channel 1 automatically.*
 - Visit www.siriusxm.com for information on the current channel lineup.
-

Subscription Updatepd- →

Press Any Key to Continue

- Your subscription has been updated.
 - Press any button to clear this message.
-

Channel Locked

- A locked channel is selected.
 - Input the passcode. On how to input passcode, refer to “Setting the Parental Control” on page 43.

Note

- *If wrong passcode is input, “Wrong Code” will be displayed and the unit will revert to the previous selected channel.*
-

Memory Short

- Buffer for Replay will full within 11 seconds.
-

Memory Full

- Buffer for Replay is full.
-

Indication for Pandora® Mode

No Pandora

- A Smartphone is not connected.
 - Make sure a Smartphone is correctly connected.
-



No Station

- You have not created any personalized Pandora® Stations.
 - When you are not driving, use the Pandora® Compatible Application on the Smartphone to create your Pandora® station(s).
-

See Device

- The music cannot be played because the Pandora® Compatible Application on the Smartphone requires the user’s attention.
 - When you are not driving, please see the Pandora® Compatible Application on the Smartphone.
-

No Service

- You switched CDE-HD149BT to Pandora® mode by pressing /**SOURCE** with a Smartphone connected, without launching or installing the Pandora® Application.
 - Launch the Pandora® Application on the Smartphone.
 - Select a source other than Pandora® by pressing /**SOURCE**.
-

Specifications

FM TUNER SECTION

Tuning Range	87.7~107.9 MHz
Mono Usable Sensitivity	9.3 dBf (0.8 μ V/75 ohms)
50 dB Quieting Sensitivity	13.5 dBf (1.3 μ V/75 ohms)
Alternate Channel Selectivity	80 dB
Signal-to-Noise Ratio	65 dB
Stereo Separation	35 dB
Capture Ratio	2.0 dB

AM TUNER SECTION

Tuning Range	530~1,710 kHz
Sensitivity (IEC Standard)	22.5 μ V/27 dB

CD PLAYER SECTION

Frequency Response	5~20,000 Hz (\pm 1 dB)
Wow & Flutter (% WRMS)	Below measurable limits
Total Harmonic Distortion	0.008% (at 1 kHz)
Dynamic Range	95 dB (at 1 kHz)
Signal-to-Noise Ratio	105 dB
Channel Separation	85 dB (at 1 kHz)

PICKUP

Wave length	795 nm
Laser power	CLASS I

USB SECTION

USB requirements	USB 1.1/2.0
Max. Power Consumption	Smartphone charge-capable
USB Class	Mass Storage
File System	FAT 12/16/32
MP3 Decoding	MPEG AUDIO Layer-3
WMA Decoding	Windows Media™ Audio
AAC Decoding	AAC-LC format “.m4a” file

BLUETOOTH SECTION

BLUETOOTH Specification	Bluetooth V2.1 + EDR
Output Power	+4 dBm Max. (Power class 2)
Profile	HFP (Hands-Free Profile) HSP (Head Set Profile) A2DP (Advanced Audio Distribution Profile) AVRCP (Audio/Video Remote Control Profile)

GENERAL

Power Requirement	14.4 V DC (11~16 V allowable)
Power Output	18 W RMS \times 4*

* Primary amplifier ratings per CEA-2006 Standard

- Power output: measured at 4 Ohms and \leq 1% THD+N
- S/N: 80 dBA (reference: 1 W into 4 Ohms)

Maximum Pre-Output Voltage	4 V/10 k ohms
Bass	\pm 9.1 dB at 100 Hz
Treble	\pm 9.1 dB at 10 kHz
Loudness	10 dB at 100 Hz
Weight	1.5 kg (3 lbs. 5 oz)

CHASSIS SIZE

Width	178 mm (7")
Height	50 mm (2")
Depth	161.5 mm (6-3/8")

NOSEPIECE SIZE

Width	168 mm (6-5/8")
Height	45 mm (1-3/4")
Depth	24 mm (1")

Note

- Due to continuous product improvement, specifications and design are subject to change without notice.

Installation and Connections

Before installing or connecting the unit, please read the following and refer to "Operating Instructions" on page 6 for proper use.

Warning

MAKE THE CORRECT CONNECTIONS.

Failure to make the proper connections may result in fire or product damage.

USE ONLY IN CARS WITH A 12 VOLT NEGATIVE GROUND.

(Check with your dealer if you are not sure.) Failure to do so may result in fire, etc.

BEFORE WIRING, DISCONNECT THE CABLE FROM THE NEGATIVE BATTERY TERMINAL.

Failure to do so may result in electric shock or injury due to electrical shorts.

DO NOT SPLICE INTO ELECTRICAL CABLES.

Never cut away cable insulation to supply power to other equipment. Doing so will exceed the current carrying capacity of the wire and result in fire or electric shock.

DO NOT DAMAGE PIPE OR WIRING WHEN DRILLING HOLES.

When drilling holes in the chassis for installation, take precautions so as not to contact, damage or obstruct pipes, fuel lines, tanks or electrical wiring. Failure to take such precautions may result in fire.

DO NOT USE BOLTS OR NUTS IN THE BRAKE OR STEERING SYSTEMS TO MAKE GROUND CONNECTIONS.

Bolts or nuts used for the brake or steering systems (or any other safety-related system), or tanks should NEVER be used for installations or ground connections. Using such parts could disable control of the vehicle and cause fire etc.

KEEP SMALL OBJECTS SUCH AS BATTERIES OUT OF THE REACH OF CHILDREN.

Swallowing them may result in serious injury. If swallowed, consult a physician immediately.

DO NOT INSTALL IN LOCATIONS WHICH MIGHT HINDER VEHICLE OPERATION, SUCH AS THE STEERING WHEEL OR GEARSHIFT.

Doing so may obstruct forward vision or hamper movement etc. and results in serious accident.

DO NOT ALLOW CABLES TO BECOME ENTANGLED IN SURROUNDING OBJECTS.

Arrange wiring and cables in compliance with the manual to prevent obstructions when driving. Cables or wiring that obstruct or hang up on places such as the steering wheel, shift lever, brake pedals, etc. can be extremely hazardous.

Caution

HAVE THE WIRING AND INSTALLATION DONE BY EXPERTS.

The wiring and installation of this unit requires special technical skill and experience. To ensure safety, always contact the dealer where you purchased this product to have the work done.

USE SPECIFIED ACCESSORY PARTS AND INSTALL THEM SECURELY.

Be sure to use only the specified accessory parts. Use of other than designated parts may damage this unit internally or may not securely install the unit in place. This may cause parts to become loose resulting in hazards or product failure.

ARRANGE THE WIRING SO IT IS NOT CRIMPED OR PINCHED BY A SHARP METAL EDGE.

Route the cables and wiring away from moving parts (like the seat rails) or sharp or pointed edges. This will prevent crimping and damage to the wiring. If wiring passes through a hole in metal, use a rubber grommet to prevent the wire's insulation from being cut by the metal edge of the hole.

DO NOT INSTALL IN LOCATIONS WITH HIGH MOISTURE OR DUST.

Avoid installing the unit in locations with high incidence of moisture or dust. Moisture or dust that penetrates into this unit may result in product failure.

Precautions

- Be sure to disconnect the cable from the (-) battery post before installing your CDE-HD149BT. This will reduce any chance of damage to the unit in case of a short-circuit.
- Be sure to connect the color coded leads according to the diagram. Incorrect connections may cause the unit to malfunction or damage to the vehicle's electrical system.
- When making connections to the vehicle's electrical system, be aware of the factory installed components (e.g. on-board computer). Do not tap into these leads to provide power for this unit. When connecting the CDE-HD149BT to the fuse box, make sure the fuse for the intended circuit of the CDE-HD149BT has the appropriate amperage. Failure to do so may result in damage to the unit and/or the vehicle. When in doubt, consult your Alpine dealer.
- The CDE-HD149BT uses female RCA-type jacks for connection to other units (e.g. amplifier) having RCA connectors. You may need an adaptor to connect other units. If so, please contact your authorized Alpine dealer for assistance.
- Be sure to connect the speaker (-) leads to the speaker (-) terminal. Never connect left and right channel speaker cables to each other or to the vehicle body.

IMPORTANT

Please record the serial number of your unit in the space provided below and keep it as a permanent record. The serial number or the engraved serial number is located on the bottom of the unit.

SERIAL NUMBER: []
INSTALLATION DATE: []
INSTALLATION TECHNICIAN: []
PLACE OF PURCHASE: []

Installation

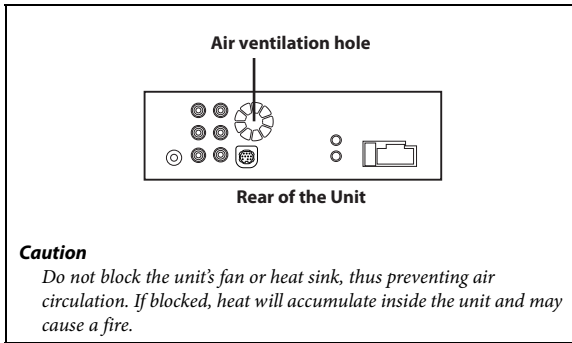

CAUTION

When you install this unit in your car, do not remove the detachable front panel. If the detachable front panel is removed during installation, you might press too hard and warp the metal plate that holds it in place. The main unit must be mounted within 35 degrees of the horizontal plane, back to front.

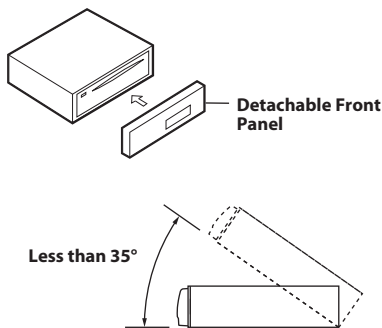

1 Remove the mounting sleeve from the main unit (Refer to "Removal" on page 52).

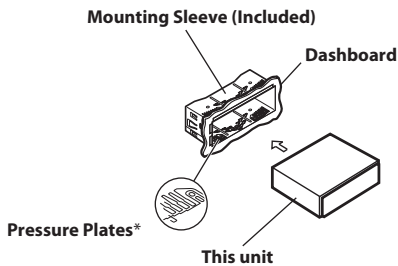

* If the installed mounting sleeve is loose in the dashboard, the pressure plates may be bent slightly to remedy the problem.

2 Reinforce the head unit with the metal mounting strap (not supplied). Secure the ground lead of the unit to a clean metal spot.

Connect each input lead coming from an amplifier to the corresponding output lead coming from the left rear of the CDE-HD149BT. Connect all other leads of the CDE-HD149BT according to details described in the CONNECTIONS section.

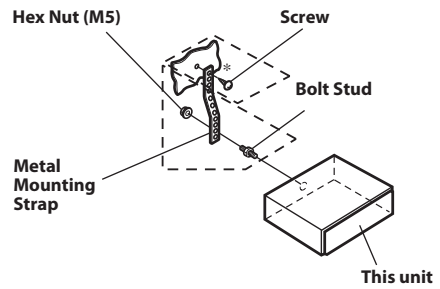

Note

- For the screw marked "*", use an appropriate screw for the chosen mounting location.

3 Slide the CDE-HD149BT into the dashboard until it clicks. This ensures that the unit is properly locked and will not accidentally come out from the dashboard. Install the detachable front panel.

Removal

- Remove the detachable front panel.
- Insert the bracket keys into the unit, along the guides on either side. The unit can now be removed from the mounting sleeve.

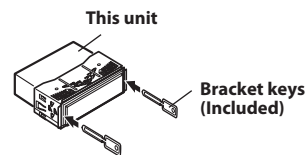

3 Pull the unit out, keeping it unlocked as you do so.

JAPANESE CAR

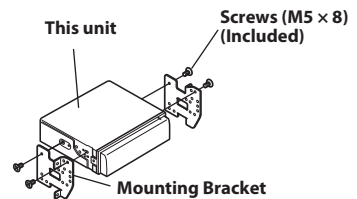
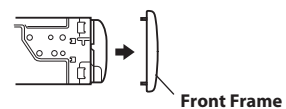

iPod/iPhone Connection (sold separately)

Connect USB cable to an iPod/iPhone with Interface cable for iPod.

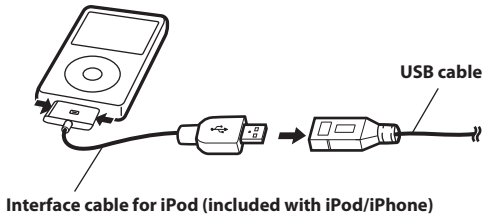

Remove the iPod/iPhone

Remove the iPod/iPhone from Interface cable for iPod.

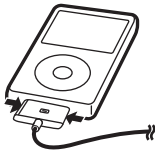

Notes

- After changing the unit to a source other than the USB iPod, remove the iPod/iPhone. If the iPod/iPhone is removed in the USB iPod mode, data may cause damage.
- If sound is not output or the iPod/iPhone is not recognized even when the iPod/iPhone is connected, remove the iPod/iPhone once, then connect it again, or reset the iPod.
- Do not leave the iPod/iPhone in a vehicle for a long time. Heat and humidity may damage the iPod/iPhone and you may not be able to play it again.

Flash Memory Connection (sold separately)

Connect Flash Memory

Connect the USB cable to the USB connector of the unit.

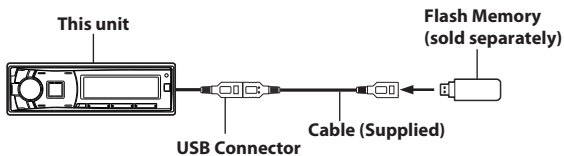

Remove Flash Memory

Pull out Flash Memory squarely from the USB cable.

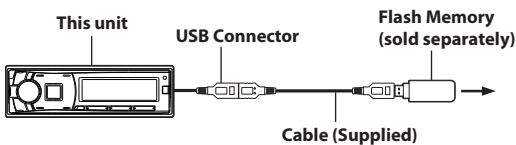

Notes

- When removing Flash Memory, pull it out straight.
- If sound is not output or Flash Memory is not recognized even when Flash Memory is connected, remove Flash Memory once, then connect it again.

- Change to a source other than the Flash Memory mode, then remove the Flash Memory. If the Flash Memory is removed in the Flash Memory mode, data may be damaged.
- Route the USB cable away from another cables.

Mounting the Microphone

For the sake of safety, mount the microphone in the following location.

- In a stable and secure location.
- In a location that does not inhibit safely driving the vehicle.
- Mount the microphone in a location where the driver's voice can easily be picked up.

Choose a location for the microphone that can easily pick up the drivers voice. Requiring the driver to move towards the microphone for audibility causes a distraction that could be dangerous.

Using the Rear AUX Input Connector

Connect a portable music player, etc. by simply connecting it to the Rear AUX Input Connector. An optional adapter cable is required (standard RCA to 3.5ø mini-phonos plug or 3.5ø to 3.5ø mini phono plug).

Press **⏮** / **SOURCE**, and select the Auxiliary mode to listen to the portable device.

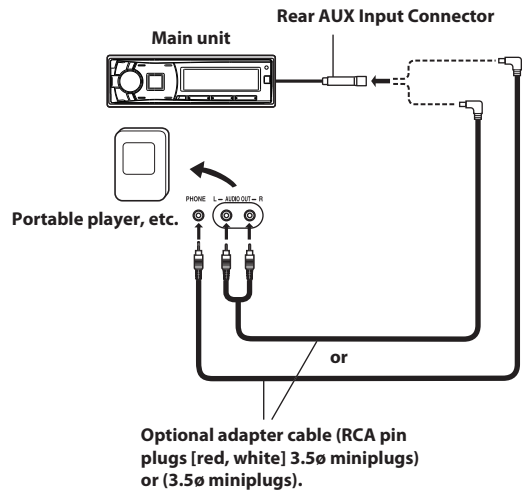

Note

- This function is available only when AUX IN is set to ON. For details, refer to "Setting the AUX SETUP mode" on page 26.

Connections

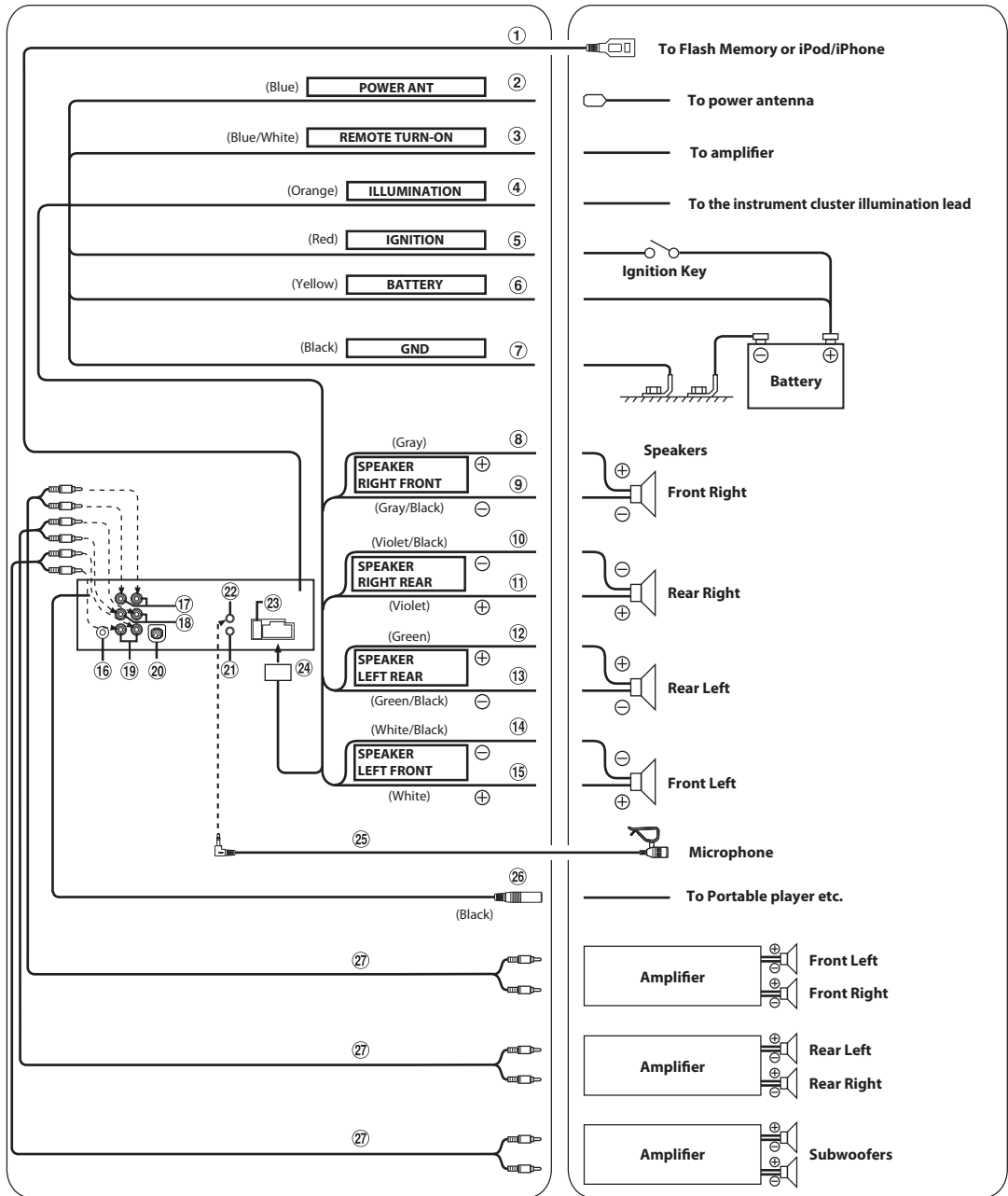

- ① **Rear USB Terminal**
Connect this to a Flash Memory or an iPod/iPhone (sold separately).
- ② **Power Antenna Lead (Blue)**
Connect this lead to the +B terminal of your power antenna, if applicable.
Note
 - This lead should be used only for controlling the vehicle's power antenna. Do not use this lead to turn on an amplifier or a signal processor, etc.
- ③ **Remote Turn-On Lead (Blue/White)**
Connect this lead to the remote turn-on lead of your amplifier or signal processor.
- ④ **Illumination Lead (Orange)**
This lead may be connected to the vehicle's instrument cluster illumination lead. This will allow the backlighting of this unit to dim whenever the vehicle's lights are turned on.
- ⑤ **Switched Power Lead (Ignition) (Red)**
Connect this lead to an open terminal on the vehicle's fuse box or another unused power source which provides (+) 12V only when the ignition is turned on or in the accessory position.
- ⑥ **Battery Lead (Yellow)**
Connect this lead to the positive (+) post of the vehicle's battery.
- ⑦ **Ground Lead (Black)**
Connect this lead to a good chassis ground on the vehicle. Make sure the connection is made to bare metal and is securely fastened using the sheet metal screw provided.
- ⑧ **Right Front (+) Speaker Output Lead (Gray)**
- ⑨ **Right Front (-) Speaker Output Lead (Gray/Black)**
- ⑩ **Right Rear (-) Speaker Output Lead (Violet/Black)**
- ⑪ **Right Rear (+) Speaker Output Lead (Violet)**
- ⑫ **Left Rear (+) Speaker Output Lead (Green)**
- ⑬ **Left Rear (-) Speaker Output Lead (Green/Black)**
- ⑭ **Left Front (-) Speaker Output Lead (White/Black)**
- ⑮ **Left Front (+) Speaker Output Lead (White)**
- ⑯ **Antenna Receptacle**
- ⑰ **Front Output RCA Connectors**
RED is right and WHITE is left.
- ⑱ **Rear Output RCA Connectors**
RED is right and WHITE is left.
- ⑲ **Subwoofer Output RCA Connectors**
RED is right and WHITE is left.
- ⑳ **SiriusXM Tuner connector**
Connect to SiriusXM Tuner.
- ㉑ **Steering Remote Control Interface Connector**
To steering remote control interface box.
You can operate this unit from the vehicle's control unit when an Alpine Steering Remote Control Interface Box (optional) is connected. For details, contact your Alpine dealer.
- ㉒ **MIC Input Connector**
To Microphone.
- ㉓ **Fuse Holder (10A)**
- ㉔ **Power Supply Connector**
- ㉕ **Microphone (Supplied)**
- ㉖ **Rear Aux Input Connector (Black)**
This connector allows for input of audio from an external device (such as a portable player), using a commercially-available converter cable.
- ㉗ **RCA Extension Cable (sold separately)**

To prevent external noise from entering the audio system.

- Locate the unit and route the leads at least 10 cm away from the car harness.
- Keep the battery power leads as far away from other leads as possible.
- Connect the ground lead securely to a bare metal spot (remove any paint, dirt or grease if necessary) of the car chassis.
- If you add an optional noise suppressor, connect it as far away from the unit as possible. Your Alpine dealer carries various noise suppressors, contact them for further information.
- Your Alpine dealer knows best about noise prevention measures so consult your dealer for further information.



LIMITED WARRANTY

ALPINE ELECTRONICS OF AMERICA, INC. AND ALPINE OF CANADA INC. ("Alpine"), are dedicated to quality craftsmanship and are pleased to offer this Warranty. We suggest that you read it thoroughly. Should you have any questions, please contact your Dealer or contact Alpine at one of the telephone numbers listed below.

● PRODUCTS COVERED:

This Warranty covers Car Audio Products and Related Accessories ("the product"). Products purchased in the Canada are covered only in the Canada. Products purchased in the U.S.A. are covered only in the U.S.A.

● LENGTH OF WARRANTY:

This Warranty is in effect for one year from the date of the first consumer purchase.

● WHO IS COVERED:

This Warranty only covers the original purchaser of the product, who must reside in the United States, Puerto Rico or Canada.

● WHAT IS COVERED:

This Warranty covers defects in materials or workmanship (parts and labor) in the product.

● WHAT IS NOT COVERED:

This Warranty does not cover the following:

- ① Damage occurring during shipment of the product to Alpine for repair (claims must be presented to the carrier).
- ② Damage caused by accident or abuse, including burned voice coils caused by over-driving the speaker (amplifier level is turned up and driven into distortion or clipping). Speaker mechanical failure (e.g. punctures, tears or rips). Cracked or damaged LCD panels. Dropped or damaged hard drives.
- ③ Damage caused by negligence, misuse, improper operation or failure to follow instructions contained in the Owner's manual.
- ④ Damage caused by act of God, including without limitation, earthquake, fire, flood, storms or other acts of nature. Any cost or expense related to the removal or reinstallation of the product.
- ⑤ Service performed by an unauthorized person, company or association.
- ⑥ Any product which has the serial number defaced, altered or removed.
- ⑦ Any product which has been adjusted, altered or modified without Alpine's consent.
- ⑧ Any product not distributed by Alpine within the United States, Puerto Rico or Canada.
- ⑨ Any product not purchased from an Authorized Alpine Dealer.

● HOW TO OBTAIN WARRANTY SERVICE:

- ① You are responsible for delivery of the product to an Authorized Alpine Service Center or Alpine for repair and for payment of any initial shipping charges. Alpine will, at its option, repair or replace the product with a new or reconditioned product without charge. If the repairs are covered by the warranty, and if the product was shipped to an Authorized Alpine Service Center or Alpine, Alpine will pay the return shipping charges.
- ② You should provide a detailed description of the problem(s) for which service is required.

③ You must supply proof of your purchase of the product.

④ You must package the product securely to avoid damage during shipment. To prevent lost packages it is recommended to use a carrier that provides a tracking service.

● HOW WE LIMIT IMPLIED WARRANTIES:

ANY IMPLIED WARRANTIES INCLUDING FITNESS FOR USE AND MERCHANTABILITY ARE LIMITED IN DURATION TO THE PERIOD OF THE EXPRESS WARRANTY SET FORTH ABOVE AND NO PERSON IS AUTHORIZED TO ASSUME FOR ALPINE ANY OTHER LIABILITY IN CONNECTION WITH THE SALE OF THE PRODUCT.

● HOW WE EXCLUDE CERTAIN DAMAGES:

ALPINE EXPRESSLY DISCLAIMS LIABILITY FOR INCIDENTAL AND CONSEQUENTIAL DAMAGES CAUSED BY THE PRODUCT. THE TERM "INCIDENTAL DAMAGES" REFERS TO EXPENSES OF TRANSPORTING THE PRODUCT TO THE ALPINE SERVICE CENTER, LOSS OF THE ORIGINAL PURCHASER'S TIME, LOSS OF THE USE OF THE PRODUCT, BUS FARES, CAR RENTALS OR OTHERS COSTS RELATING TO THE CARE AND CUSTODY OF THE PRODUCT. THE TERM "CONSEQUENTIAL DAMAGES" REFERS TO THE COST OF REPAIRING OR REPLACING OTHER PROPERTY WHICH IS DAMAGED WHEN THIS PRODUCT DOES NOT WORK PROPERLY. THE REMEDIES PROVIDED UNDER THIS WARRANTY ARE EXCLUSIVE AND IN LIEU OF ALL OTHERS.

● HOW STATE/PROVINCIAL LAW RELATES TO THE WARRANTY:

This Warranty gives you specific legal rights, and you may also have other rights which vary from state to state and province to province. In addition, some states/provinces do not allow limitations on how long an implied warranty lasts, and some do not allow the exclusion or limitation of incidental or consequential damages. Accordingly, limitations as to these matters contained herein may not apply to you.

● IN CANADA ONLY:

This Warranty is not valid unless your Alpine car audio product has been installed in your vehicle by an Authorized Installation Center, and this warranty stamped upon installation by the installation center.

● HOW TO CONTACT CUSTOMER SERVICE:

Should the product require service, please call the following number for your nearest Authorized Alpine Service Center.

CAR AUDIO	1-800-ALPINE-1 (1-800-257-4631)
NAVIGATION	1-888-NAV-HELP (1-888-628-4357)

Or visit our website at; <http://www.alpine-usa.com>

ALPINE ELECTRONICS OF AMERICA, INC., 19145 Gramercy Place, Torrance, California 90501, U.S.A.

ALPINE ELECTRONICS OF CANADA, INC., 777 Supertest Road, Toronto, Ontario M3J 2M9, Canada

Do not send products to these addresses.

Call the toll free telephone number or visit the website to locate a service center.

About the Rules of Bluetooth Electromagnetic Radiation Regulation

USA/Canada	FCC CAUTION Changes or modifications not expressly approved by the party responsible for compliance could void the user's authority to operate the equipment. This device complies with Part 15 of FCC Rules and Industry Canada licence-exempt RSS standard(s). Operation is subject to the following two conditions: (1) this device may not cause interference, and (2) this device must accept any interference, including interference that may cause undesired operation of this device. Le présent appareil est conforme aux la partie 15 des règles de la FCC et CNR d'Industrie Canada applicables aux appareils radio exempts de licence. L'exploitation est autorisée aux deux conditions suivantes : (1) l'appareil ne doit pas produire de brouillage, et (2) l'utilisateur de l'appareil doit accepter tout brouillage radioélectrique subi, même si le brouillage est susceptible d'en compromettre le fonctionnement. This equipment complies with FCC/IC radiation exposure limits set forth for an uncontrolled environment and meets the FCC radio frequency (RF) Exposure Guidelines in Supplement C to OET65 and RSS-102 of the IC radio frequency (RF) Exposure rules. This equipment has very low levels of RF energy that it deemed to comply without maximum permissive exposure evaluation (MPE). But it is desirable that it should be installed and operated keeping the radiator at least 20cm or more away from person's body (excluding extremities: hands, wrists, feet and ankles). Cet équipement est conforme aux limites d'exposition aux rayonnements énoncées pour un environnement non contrôlé et respecte les règles les radioélectriques (RF) de la FCC lignes directrices d'exposition dans le Supplément C à OET65 et d'exposition aux fréquences radioélectriques (RF) CNR-102 de l'IC. Cet équipement émet une énergie RF très faible qui est considérée conforme sans évaluation de l'exposition maximale autorisée. Cependant, cet équipement doit être installé et utilisé en gardant une distance de 20 cm ou plus entre le dispositif rayonnant et le corps (à l'exception des extrémités : mains, poignets, pieds et chevilles).
México	La operación de este equipo está sujeta a las siguientes dos condiciones: (1) es posible que este equipo o dispositivo no cause interferencia perjudicial y (2) este equipo o dispositivo debe aceptar cualquier interferencia, incluyendo la que pueda causar su operación no deseada.



ANATEL

MODELO: UGZZC-G
2717-12-4557



(01) 07898936509123

Este equipamento opera em caráter secundário, isto é, não tem direito a proteção contra interferência prejudicial, mesmo de estações do mesmo tipo, e não pode causar interferência a sistemas operando em caráter primário.

Don't forget to take a moment to protect your purchase by registering your product now at the following address: www.alpine-usa.com/registration.

N'oubliez pas de consacrer un moment à la protection de votre achat en enregistrant votre produit dès maintenant à l'adresse suivante : www.alpine-usa.com/registration.

Recuerde que con solo unos pocos pasos podrá proteger su producto, registrándolo a través de la siguiente dirección: www.alpine-usa.com/registration.